

**SHEL LAB**<sup>®</sup>

# **SMO-HP Series**

## **High Performance Ovens**

**SMO5HP-2 • SMO10HP-2 • SMO14HP-2**  
**SMO28HP-2 • SMO38HP-2**



SHEL LAB is a Sheldon Manufacturing Brand. P/N 0740605. Rev. 2024.

FOLLOW US ON:    

**SHEL LAB High-performance forced air lab ovens are versatile tools used in a wide range of applications across various industries. Their ability to maintain uniform temperatures and provide precise control makes them ideal for several critical processes. High-performance forced air lab ovens are essential in these applications due to their reliability, efficiency, and ability to maintain consistent thermal environments. Their versatility and precision make them invaluable tools in laboratories and industrial settings alike. The SMOHP ovens are engineered for safe, accurate, and uniform performance in demanding laboratory environments.**



- + Fast ramp-up to 306°C for faster cycle times.
- + Temperature range approximately 15°C above ambient to 306°C for multiple applications.
- 1 Advanced PID temperature control system for sensitive response.
- 2 **NEW** Watlow PM9 Plus Controller.
- 3 Independent overtemperature set point and operational control override for additional safety.
- 4 Stainless steel interior construction for long life operation, easy cleaning.
- 5 High performance forced-air circulation to assure maximum temperature uniformity.
- 6 Triple-wall construction to minimize external surface temperature.
- 7 Stainless steel shelves are adjustable on 0.5" (12.7 mm) centers to provide flexible inventory options.
- 8 Rear access port\*, 1.75" diameter (44.4 mm) for independent cables, instrumentation.
- 9 Exhaust port, 2.75" diameter (70 mm), adjustable, with external connection to customer-supplied vent for effluent exhaust if required.
- + Internationally certified CAN/CSA, UL, EN, IEC 61010, and compliant with CE.
- + Two year warranty.

High Performance Ovens are available in 220-240V, 50/60Hz configurations and achieve temperatures up to 306°C with fast ramp-up and recovery times.

**Heat-Up** - Rapid heat-up times to 306°C depend on voltage selected. Published heat-up performance is based on a standard cabinet under controlled testing at a 22°C ambient temperature, line voltage ±10% of specified voltage.

**Recovery** - Upper vents are closed when recovery times following door openings are tested. Published recovery performance is based on a standard cabinet under controlled testing at a (22 ± 3)°C ambient temperature, line voltage ±10% of specified voltage.

- ## Applications:
- Asphalt Testing
  - ASTM, UL and Life Testing
  - Baking, Conditioning, Curing
  - Moisture and Stability Testing
  - Drying
  - Burn-In
  - Aging





## Control, Timer Program, and Monitoring

The Watlow PM9 Plus PID (proportional, integral, derivative) controller commands proportional power to the heating elements to provide the most accurate and responsive control. The control parameters are matched to the oven size to assure faster response to setpoint with minimal overshoot and quicker recovery following door openings. Also, the controller supports custom recipe creation for full ramp and soak control

for any custom applications. A total of 4 recipes with up to 40 steps can be used to configure the oven to your process. The on-board timer permits programmed dwell cycles with automatic shut-off for custom applications. Indicator lights are included for visual status feedback on critical functions. All controls are centrally located on the main panel including manual power and timer on/off switches, independent over-temperature control, digital temperature set point adjustments, and indicator lights for all functions.

**Main Power on/off switch**  
**Temperature setpoint**  
**Temp Controller displays temperature, set-point, and profile status**  
**Built-In High Limit Control digital set-point**  
**Up Temp\*\***  
**Down Temp\*\***  
**Red Display current temp**

*\*\*Up/Down Increment Key: Scroll up or down lists using the + or - keys Numeric Slider: Increase or decrease numeric parameters with the slider.*



## New Watlow PM9+



Temperature Controller - Display on Homepage

**Top Line (Red):** Present chamber shelving temperature

**Middle Line (Green):** The constant temperature setpoint

**Bottom Line:** Flashing "2" indicates active heating.

**Bottom Line:** "3" indicates the blower is on.

The Home button allows immediate navigation back to the home screen, where it displays the current temperature and the set

temperature.

While on the homepage, use the (+) and (-) buttons or swipe up or down on the +/- bar to alter the constant temperature setpoint. On Operations pages, these controls are used to select Operation options, modify the high limit setpoint, adjust calibration offsets, and configure program variables.

From the homepage, pressing the forward arrow button progresses through various parameter option pages, such as Event 1 and Units of Measurement (Celsius or Fahrenheit). This button is also used

for advancing through menus and parameter lists while programming a temperature recipe.

The back arrow button takes the display back to the previous page or menu. Continuously pressing this button will eventually navigate the display back to the homepage.

Pressing the left Fn button activates Profile Program 1. Pressing it again during its execution will stop Program 1. Similarly, the right Fn button initiates Profile Program 2 (Step 11) and pressing the button a second time while it is running will halt Program 2

## Unit Specs, and Accessory Guides

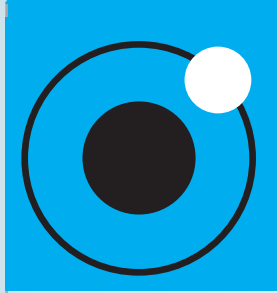

	SMO5HP-2	SMO10HP-2	SMO14HP-2	SMO28HP-2	SMO38HP-2
<b>Part Number</b>	<b>SLFHP523-H</b>	<b>SLFHP1023-H</b>	<b>SLFHP1423-H</b>	<b>SLFHP2823-H</b>	<b>SLFHP3823-H</b>
<b>Wall Clearance/Sides</b>	6.0" (152 mm)	6.0" (152 mm)	6.0" (152 mm)	6.0" (152 mm)	6.0" (152 mm)
<b>Wall Clearance/Rear</b>	12.0" (305 mm)	12.0" (305 mm)	12.0" (305 mm)	12.0" (305 mm)	12.0" (305 mm)
<b>Unit Weight Empty</b>	325 lb (147 kg)	357 lb (163 kg)	449 lb (203.7 kg)	569.4 lb (258.3 kg)	595 lb (270 kg)
<b>Shipping Weight</b>	412 lb (187 kg)	450 lb (204 kg)	563 lb (255 kg)	694 lb (315 kg)	1078 lb (489 kg)
<b>Controller</b>	<b>Watlow PM9 Plus</b>	<b>Watlow PM9 Plus</b>	<b>Watlow PM9 Plus</b>	<b>Watlow PM9 Plus</b>	<b>Watlow PM9 Plus</b>
<b>Interior Volume</b>	4.9 cu.ft. (139 Liters)	10.6 cu.ft. (301 Liters)	14.6 cu.ft. (413 Liters)	28 cu.ft. (792 Liters)	38 cu.ft. (1083 liters)
<b>Exterior Dimensions W x D x H</b>	35.0" x 30.0" x 37.6" 889 x 747 x 955 mm	44.1" x 29.9" x 56.7" 1121 x 760 x 1440 mm	59" x 28" x 30" 1499 x 711 x 1448 mm	42.5" x 34.1" x 85.9" 1080 x 866 x 2182 mm	68" 33.3" x 79.4" 1728 x 846 x 2017 mm
<b>Interior Dimensions W x D x H</b>	20.5" x 20.7" x 20" 520 x 527 x 508mm	29.8" x 20.6" x 30" 757 x 524 x 762 mm	44" x 20.8" x 30" 1117 x 528 x 762 mm	31.7" x 26" x 60.9" 805 x 660 x 1546 mm	47.8" x 27.8" x 54.1" 1214 x 706 x 1372 mm
<b>Exterior Construction</b>	300 Series Stainless Steel	300 Series Stainless Steel	300 Series Stainless Steel	300 Series Stainless Steel	300 Series Stainless Steel
<b>Interior Construction</b>	20 Gauge Steel Powder Coated	20 Gauge Steel Powder Coated	20 Gauge Steel Powder Coated	20 Gauge Steel Powder Coated	20 Gauge Steel Powder Coated
<b>Shelves*</b>	2 Standard, 4 Total	3 Standard, 8 Total	6 Standard, 14 Total	6 Standard, 12 Total	12 Standard, 20 Total
<b>Maximum Weight Per Shelf</b>	50 lb / 22.7 kg	75 lb / 34 kg	75 lb / 34 kg	75 lb / 34 kg	75 lb / 34 kg
<b>Permitted Total Load</b>	75 lb / 34 kg	225 lb / 102 kg	450 lb / 204 kg	450 lb / 204 kg	900 lb / 408 kg
<b>Temperature Uniformity</b>	3.5 at 306°C	5.5 at 306°C	5.5 at 260°C	5.5 at 306°C	5.5 at 306°C
<b>Operating Range</b>	Ambient 15-40°C	Ambient 15-40°C	Ambient 15-40°C	Ambient 15-40°C	Ambient 15-40°C
<b>Stability</b>	0.4 at 306°C	0.4 at 306°C	0.4 at 260°C	0.4 at 306°C	0.4 at 306°C
<b>Caster Platform</b>	9000584	9000542	9000541	9000539	9000540
<b>Power Exhaust Blower, 230V</b>	9990741	9990741	9990741	9990741	9990741
<b>RS485 USB Converter Cable</b>	9490586	9490586	9490586	9490586	9490586
<b>Extra Shelf, Slides*, Clips</b>	9751249	9751248	9751247	9751245	9751246

\*Slides for SMO5HP-2 only      \*Extra shelves available      Contact [support@sheldonmfg.com](mailto:support@sheldonmfg.com) for additional information.

**Sheldon Manufacturing, Inc.**  
**300 N. 26th Avenue • PO Box 627 • Cornelius, OR 97113 USA**  
**+1-503-640-3000 • [sales@sheldonmfg.com](mailto:sales@sheldonmfg.com)**

# SMO-HP Series



## **Drying and Curing**

**Materials and Samples:** Removal of moisture from samples, including powders, granules, and electronic components.

**Coatings and Paints:** Curing of coatings, adhesives, and paint on various substrates.

## **Sterilization**

**Laboratory Glassware:** Sterilizing glassware, and other general laboratory.

**Medical Devices:** Sterilizing some medical and dental.

## **Baking and Conditioning**

**Polymer Curing:** Baking polymers and composites to achieve desired mechanical properties.

**Rubber and Plastics:** Conditioning rubber and plastic samples for testing or further processing.



## **Annealing**

**Metals and Alloys:** Heat treating metals to relieve internal stresses and improve ductility.

**Glass and Ceramics:** Annealing glass and ceramic products to enhance strength and durability.

## **Aging and Stability Testing**

**Pharmaceuticals:** Aging studies on pharmaceutical products to determine shelf life.

**Materials Testing:** Stability testing of materials under various temperature conditions.

## **Evaporation**

**Solvent Removal:** Evaporating solvents from samples, particularly in chemical and biochemical laboratories.

**Concentration:** Concentrating solutions by removing excess solvent.



# High Performance Ovens



SMO38HP-2



SMO28HP-2





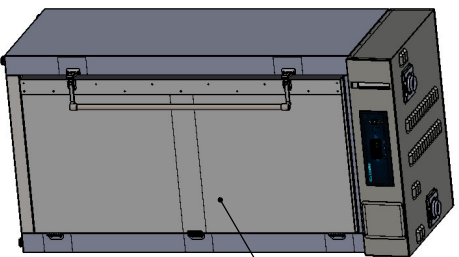
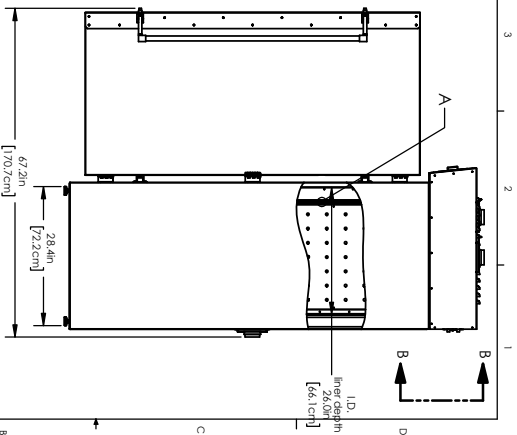
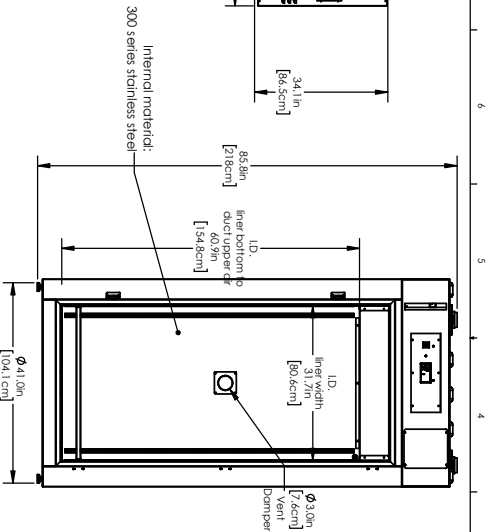
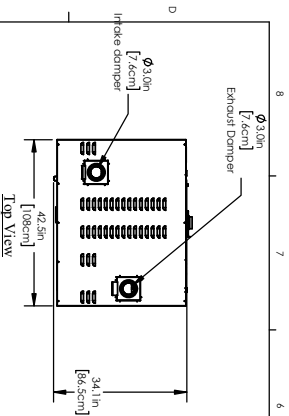

External material:  
Cold rolled mild steel  
Powder coated

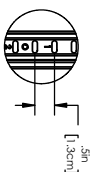
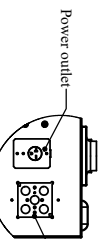
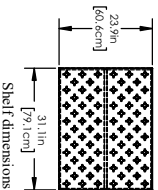

**SHEL LAB**

Sheldon Manufacturing, Inc  
300 N 26th Ave  
Cornelius, OR 97113  
www.shellab.com

Back of control box

Shelf standard spacing

MODEL: SLPHHP2823-H

DATE: 05/03/20

NAME: SMO28HP-2

SIZE: 19" W x 26" H

REV: 1

SCALE: 1/2" = 1"

SHEET 1 OF 1

INDICATIONS CONTAINED IN THIS DRAWING ARE THE PROPERTY OF SHELDON MANUFACTURING, INC. AND ARE NOT TO BE REPRODUCED OR TRANSMITTED IN ANY FORM OR BY ANY MEANS, ELECTRONIC OR MECHANICAL, INCLUDING PHOTOCOPYING, RECORDING, OR BY ANY INFORMATION STORAGE AND RETRIEVAL SYSTEM.

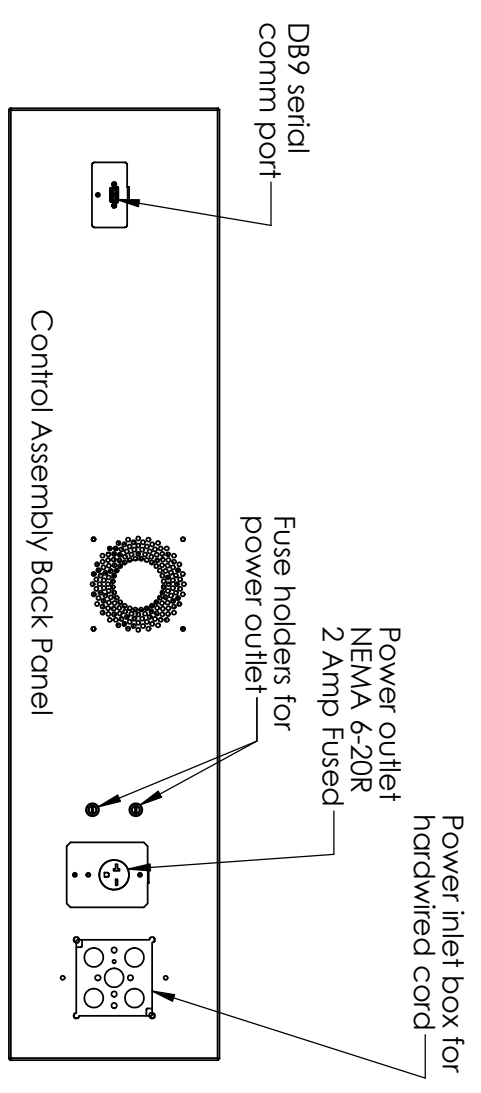
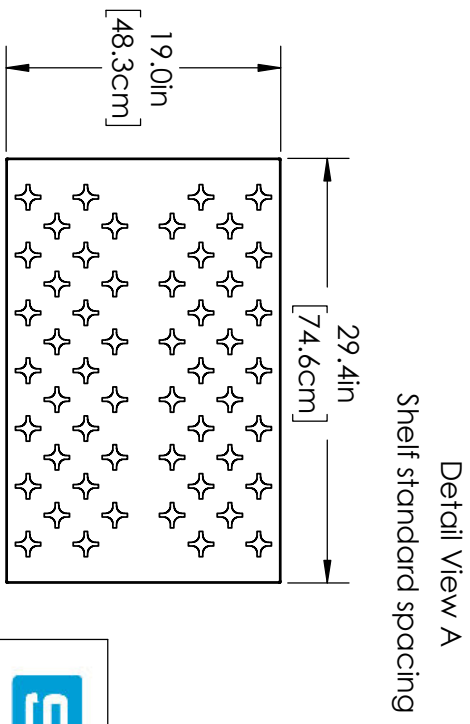
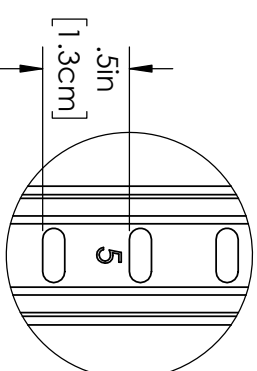
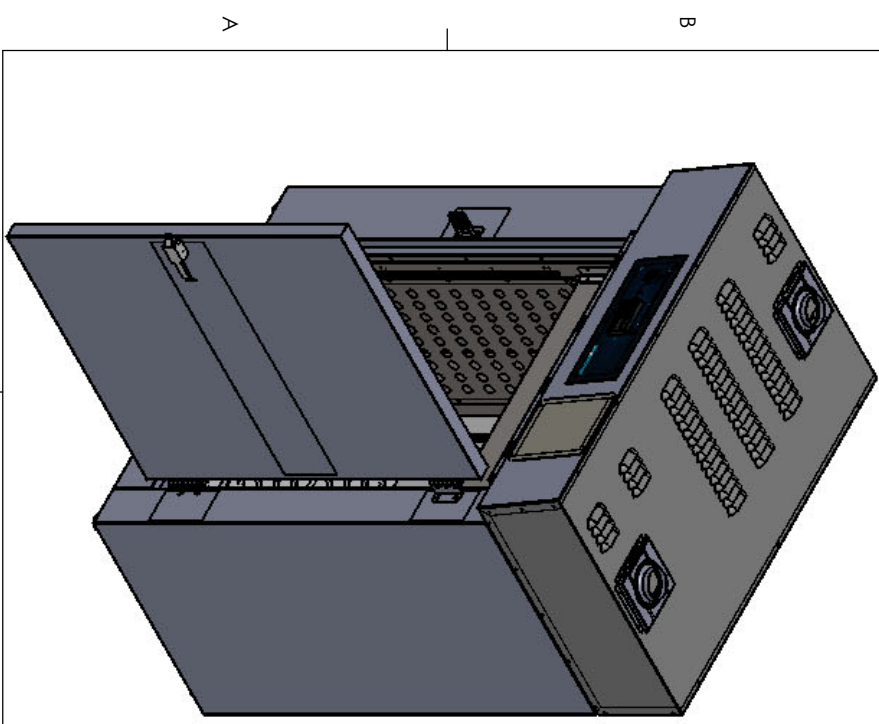
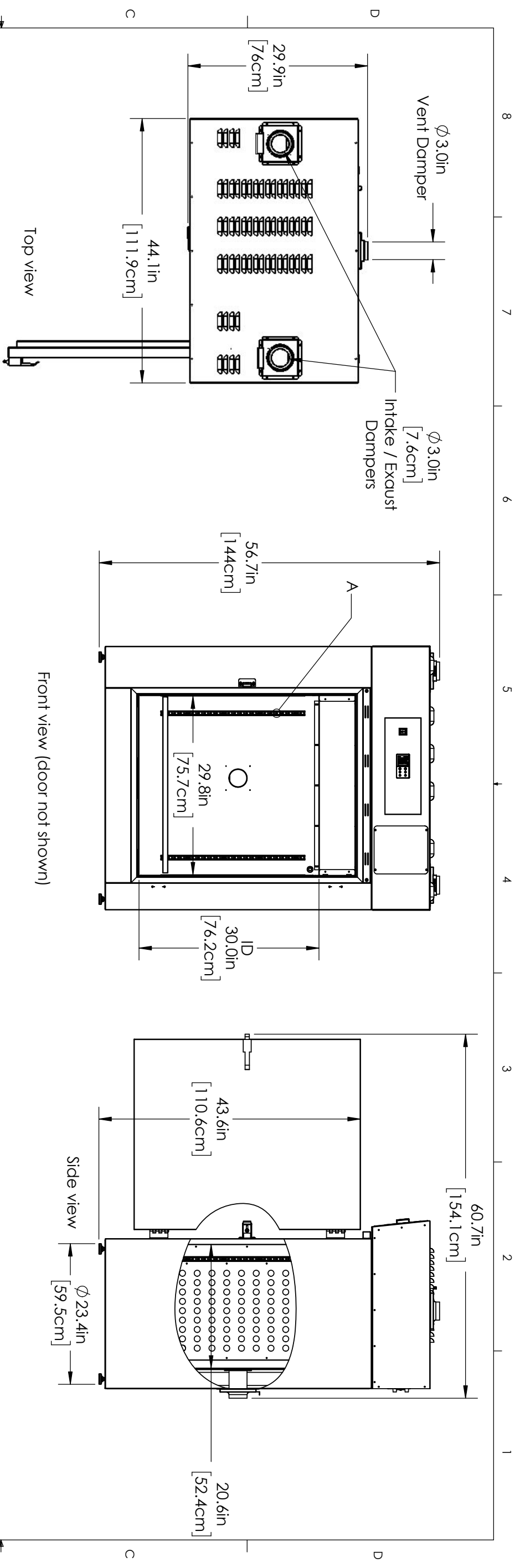

		NAME	DATE	<b>MODEL:</b> <b>SLEHP1023-H</b> <b>SMO10HP-2</b>
		DRAWN	7/9/08	
Sheldon Manufacturing, Inc 300 N 26th Ave Cornelius, OR 97113 www.shellab.com		PROPRIETARY AND CONFIDENTIAL THE INFORMATION CONTAINED IN THIS DRAWING IS THE SOLE PROPERTY OF SHELDON MFG. ANY REPRODUCTION IN PART OR AS A WHOLE WITHOUT THE WRITTEN PERMISSION OF Sheldon MFG. IS PROHIBITED.		<b>SIZE:</b> <b>B</b>
SCALE: 1:48		WEIGHT:		<b>DWG. NO.:</b> 9071428
SHEET 1 OF 1		REV		<b>REV</b>

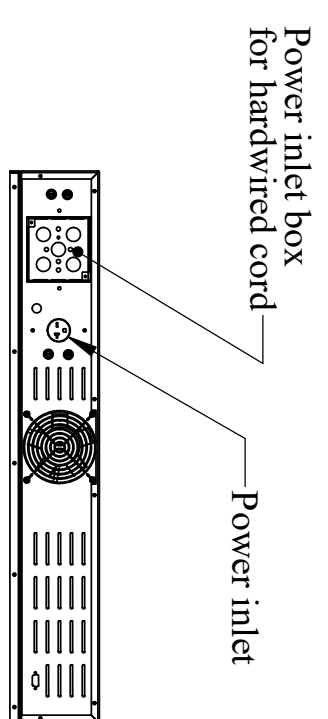
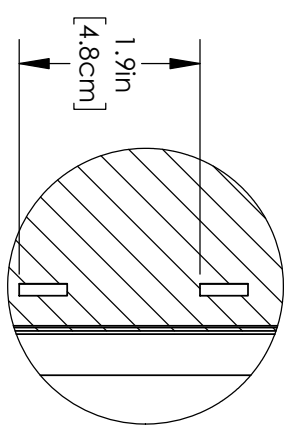
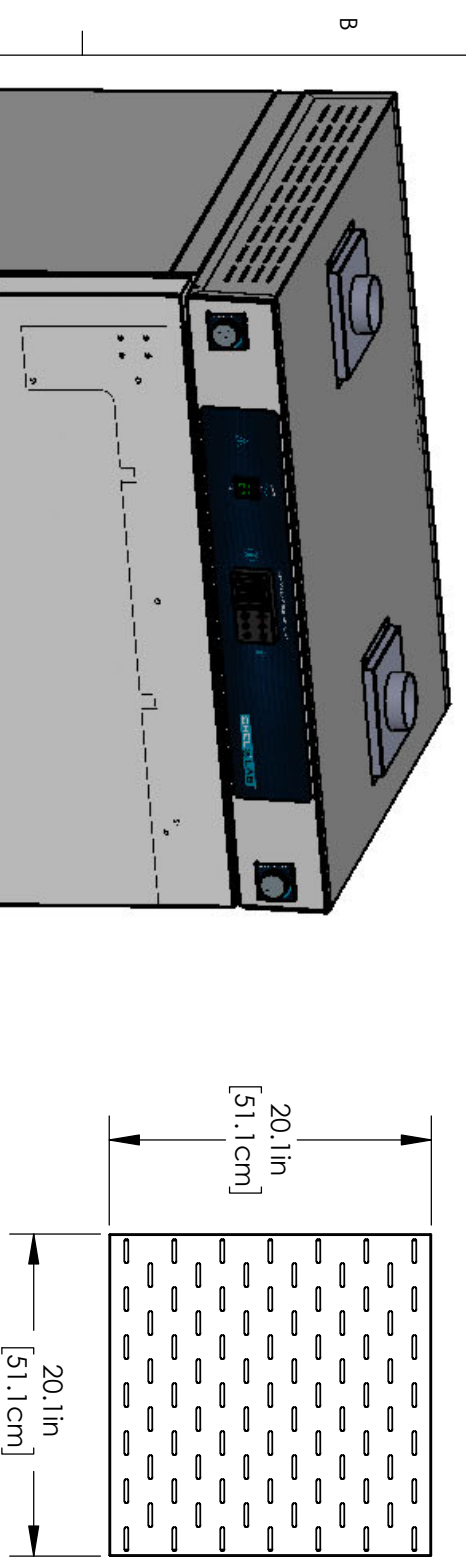
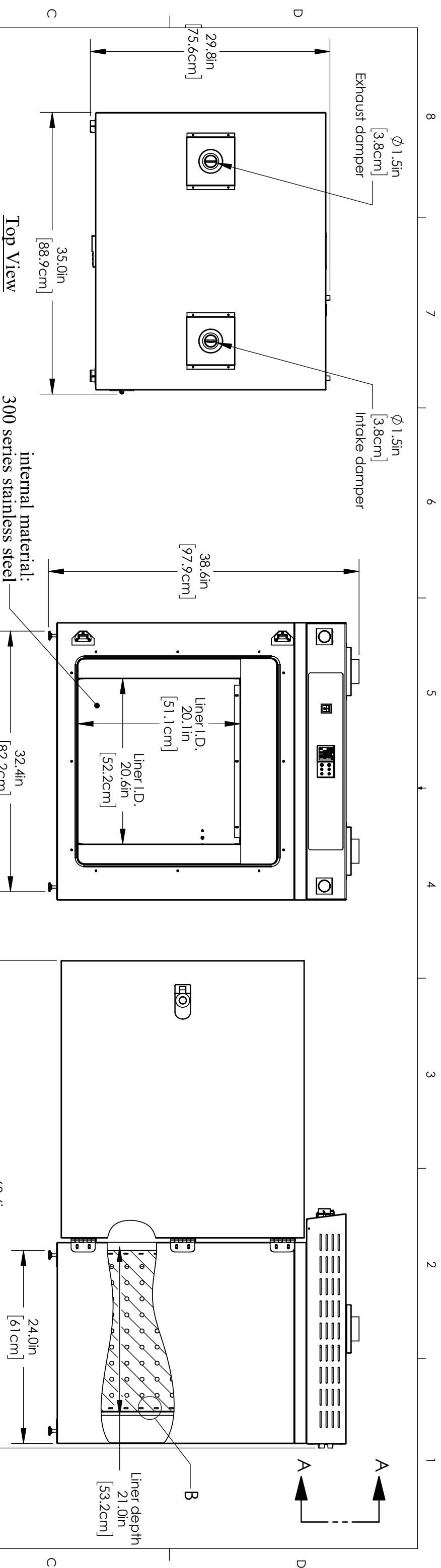

External material:  
Cold rolled mild steel  
powder coated



Sheldon Manufacturing, Inc  
300 N 26th Ave Cornelius, OR 97113  
www.shellab.com

DRAWN	NAME	DATE	MODEL:
Pk		3/3/2016	<b>SLFHP523-H</b>
<small>PROPRIETARY AND CONFIDENTIAL</small> <small>THE INFORMATION CONTAINED IN THIS DRAWING IS THE SOLE PROPERTY OF SHELDON MFG. ANY REPRODUCTION IN PART OR AS A WHOLE WITHOUT THE WRITTEN PERMISSION OF Sheldon MFG. IS PROHIBITED.</small>			<b>SMO5HP-2</b>
SIZE	DWG. NO.	REV	
<b>B</b>	9071435		

SCALE: 1:1.2 WEIGHT: SHEET 3 OF 3



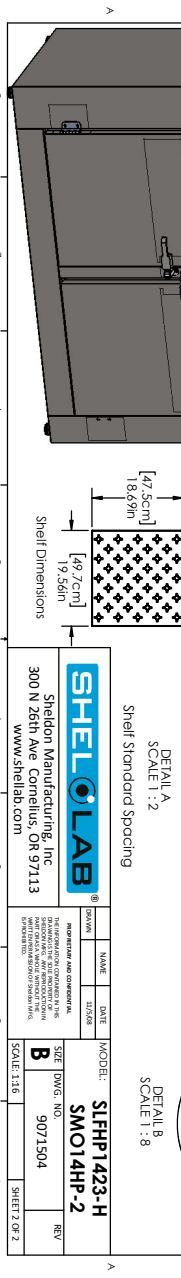
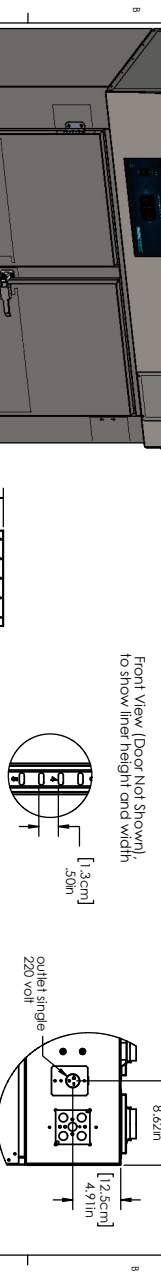
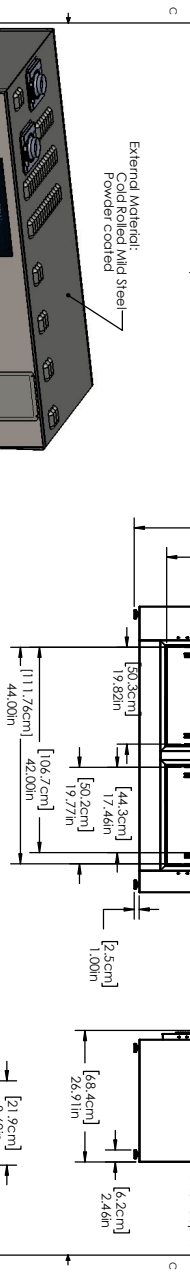
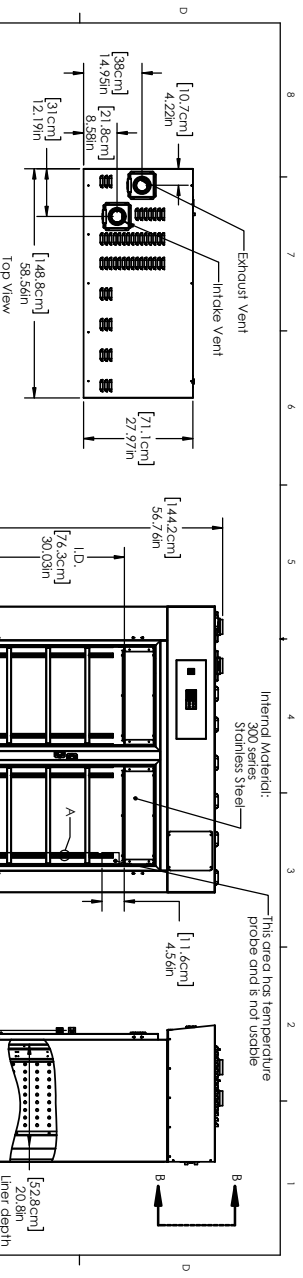

<b>SHELL LAB</b>		<b>SHIELDON MANUFACTURING, INC.</b>	
INDUSTRIAL INFORMATION CONTAINED IN THIS DRAWING IS UNCLASSIFIED EXCEPT WHERE SHOWN OTHERWISE. ALL RIGHTS RESERVED. THIS DRAWING IS THE PROPERTY OF SHIELDON MANUFACTURING, INC. AND IS NOT TO BE REPRODUCED OR TRANSMITTED IN ANY FORM OR BY ANY MEANS, ELECTRONIC OR MECHANICAL, INCLUDING PHOTOCOPYING, RECORDING, OR BY ANY INFORMATION STORAGE AND RETRIEVAL SYSTEM.		300 N 26th Ave Cornelius, OR 97113 www.shieldon.com	
DATE: 07/2025	NAME: SIZ/2025	MODEL: SIFHP1423-H	REV: REV
SCALE: 1:16	SCALE: 1:16	SIZE DWG. NO.: SM014HP-2	SCALE: 1:16
SHEET 7 OF 2		SHEET 7 OF 2	

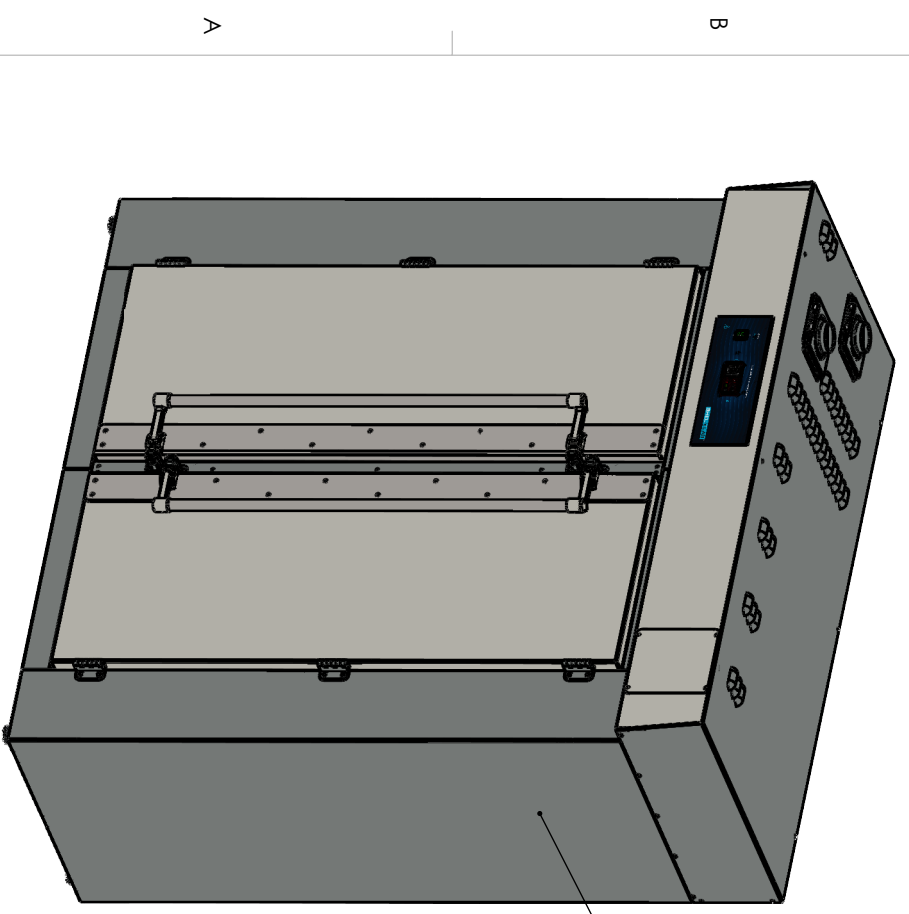
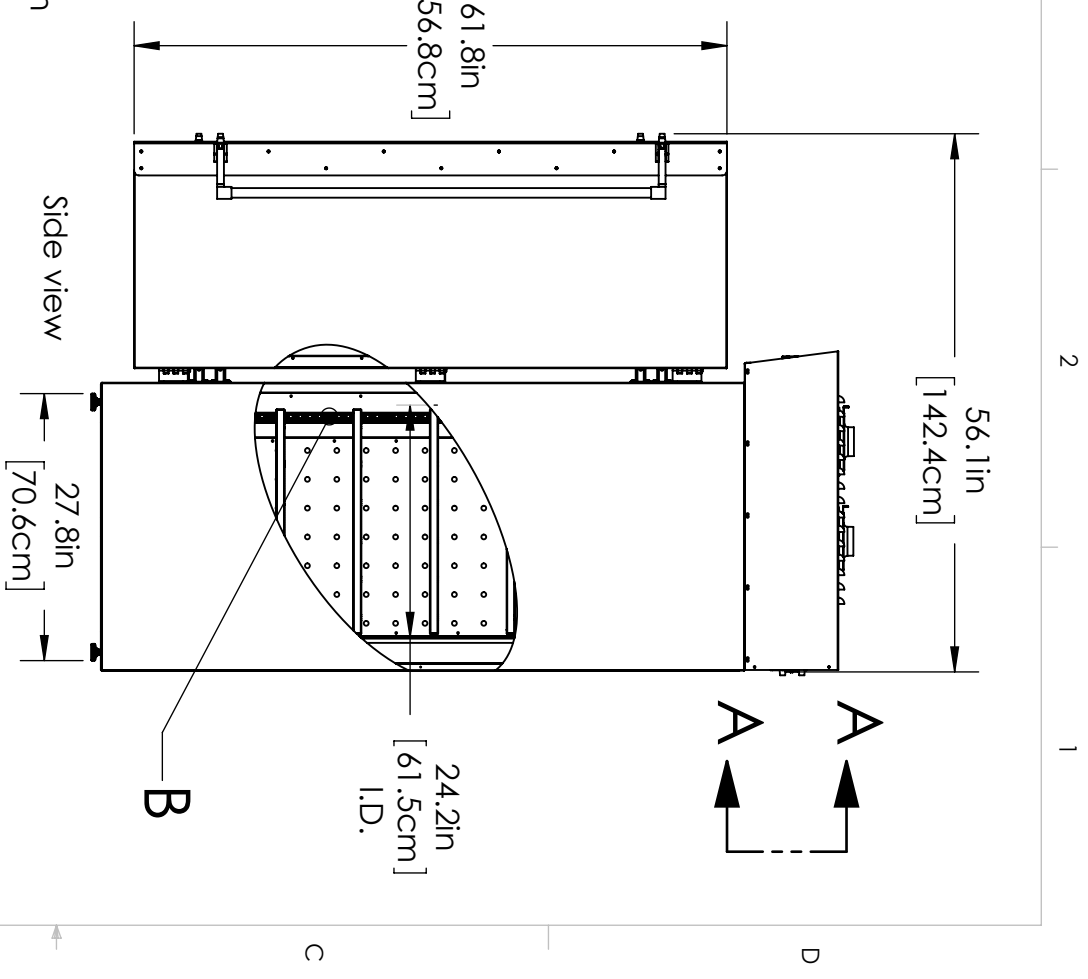
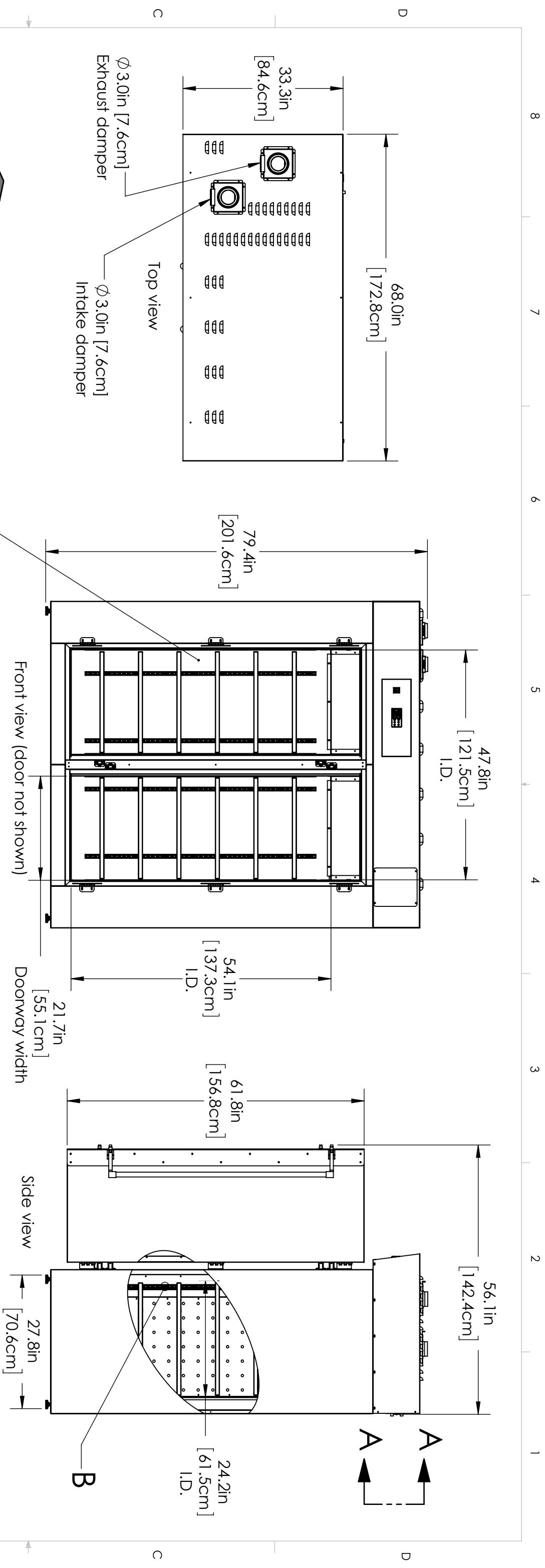
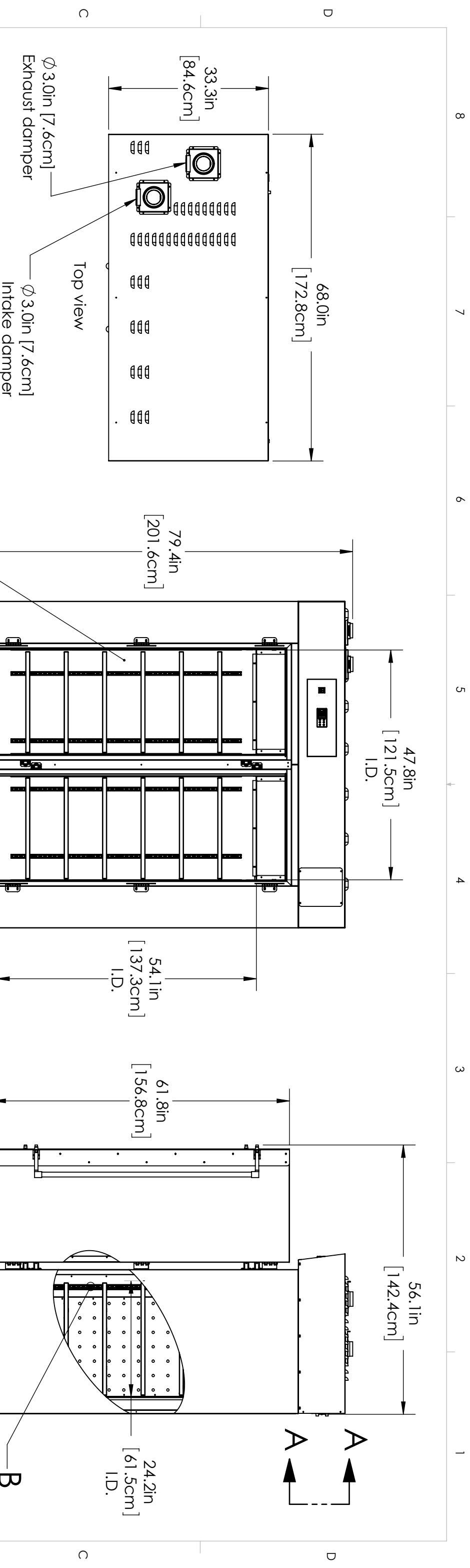

Internal material:  
300 series stainless steel

External material:  
Cold rolled mild steel  
Powder coated

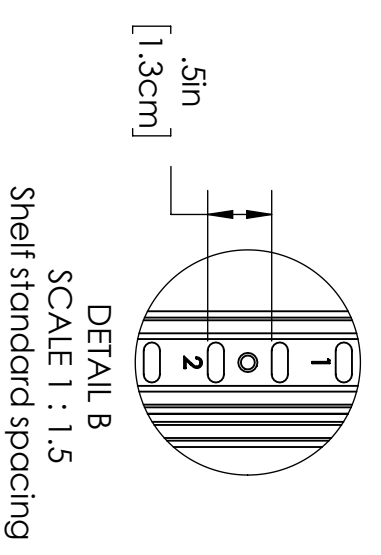
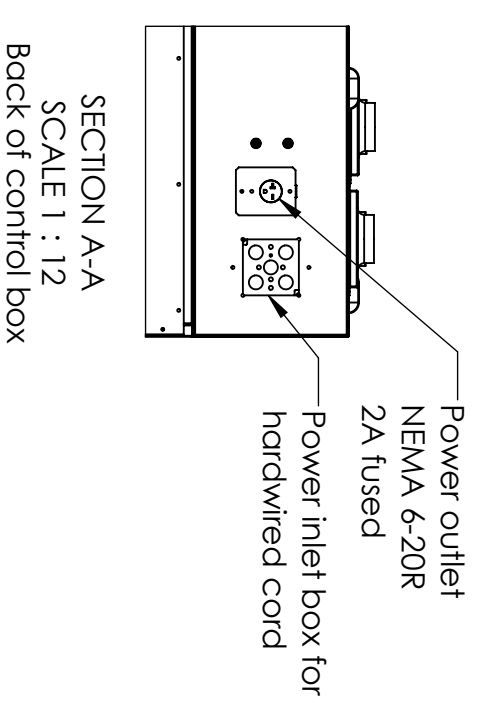
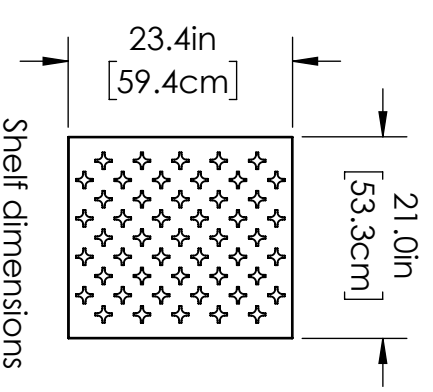

Sheldon Manufacturing, Inc  
300 N 26th Ave  
Cornelius, OR 97113  
www.shellab.com

DRAWN	NAME	DATE
PK		6/25/2015

PROPRIETARY AND CONFIDENTIAL

THE INFORMATION CONTAINED IN THIS DRAWING IS THE SOLE PROPERTY OF SHELDON MFG. ANY REPRODUCTION IN PART OR AS A WHOLE WITHOUT THE WRITTEN PERMISSION OF Sheldon MFG. IS PROHIBITED.

MODEL: SLFHP3823-H/SMO38HP-2

SIZE DWG. NO. **B** 9071506

SCALE: 1:20 WEIGHT: SHEET 1 OF 1

8 7 6 5 4 3 2 1

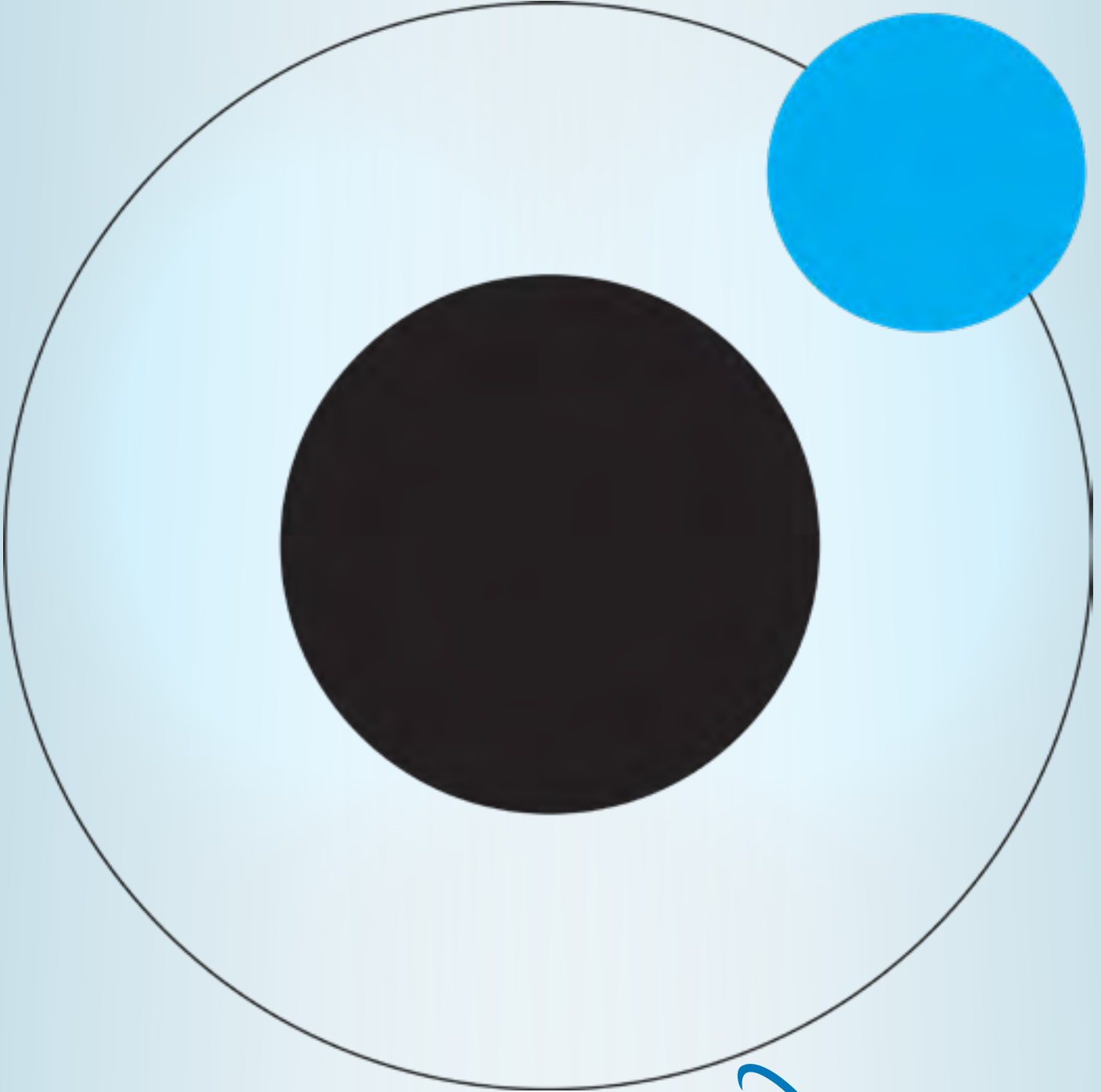

**SHELDON**  
MANUFACTURING.INC

**Sheldon Manufacturing, Inc.**  
**300 N. 26th Avenue • PO Box 627 • Cornelius, OR 97113 USA**  
**+1-503-640-3000 • sales@sheldonmfg.com**

SHEL LAB is a Sheldon Manufacturing Brand. P/N 0740605. Rev. 2024.

