

# ECONOMY GRAVITY OVENS 110 - 120 Voltage

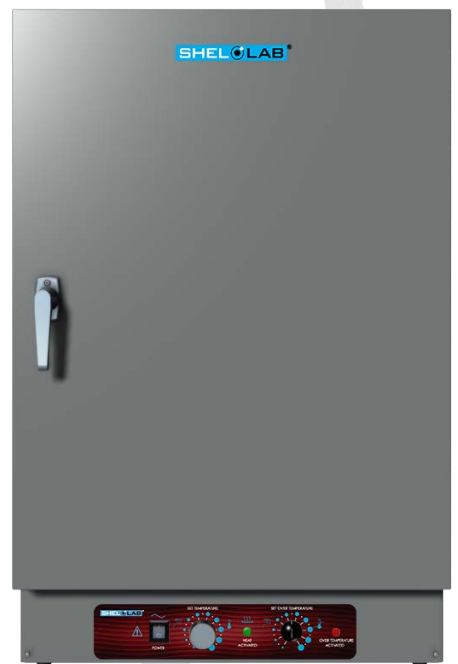
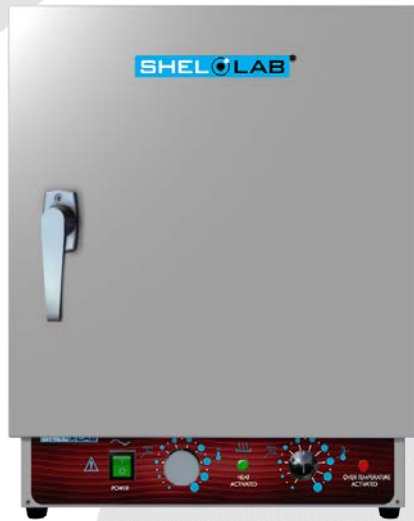

## Installation - Operation Manual

SGO1E

SGO6E

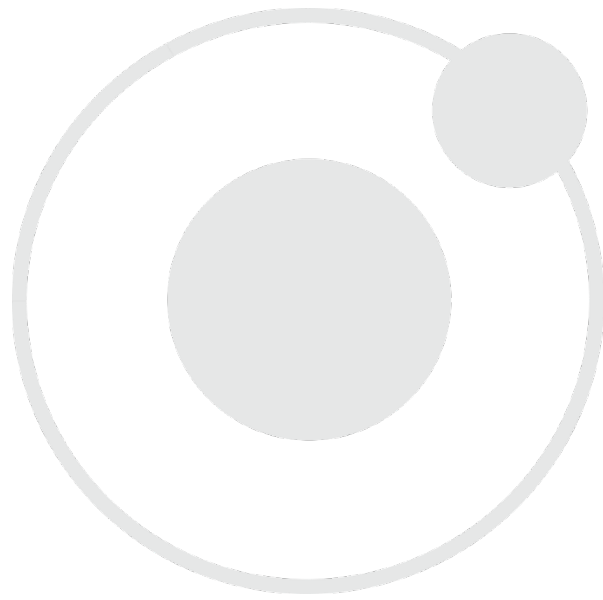

# SGO Economy Gravity Ovens

**110 - 120 Voltage**

**Part Number (Manual): 4861566**

**Revision: December 5, 2017**

**Pictured on Cover: Left to right SGO1E, SGO6E**



SHEL LAB is a brand of Sheldon Manufacturing, INC.

These units are intended for professional, industrial, or educational use where the preparation or testing of materials is done at an ambient air pressure range of 22.14 – 31.3 inHg (75 – 106 kPa) and no flammable, volatile, or combustible materials are being heated. These units are compatible with the following standards.

CAN/CSA-22.2 No. 61010-1:2012/U2:2016-04

CAN/CSA-C22.2 No. 61010-2-010:2015

UL 61010-1:2012/R:2016-04

UL 61010-2-010:2015

EN 61010-1:2010

EN 61010-2-010:2014

# TABLE OF CONTENTS

<b>INTRODUCTION .....</b>	<b>5</b>
<i>Read this Manual.....</i>	<i>5</i>
<i>Safety Considerations and Requirements .....</i>	<i>5</i>
<i>Contacting Assistance .....</i>	<i>6</i>
<i>Engineering Improvements.....</i>	<i>6</i>
<b>RECEIVING YOUR UNIT .....</b>	<b>7</b>
<i>Inspect the Shipment.....</i>	<i>7</i>
<i>Orientation Photos.....</i>	<i>8</i>
<i>Recording Data Plate Information .....</i>	<i>11</i>
<b>INSTALLATION .....</b>	<b>13</b>
<i>Installation Procedure Checklist .....</i>	<i>13</i>
<i>Required Ambient Conditions.....</i>	<i>14</i>
<i>Required Ventilation Clearances.....</i>	<i>14</i>
<i>Environmental Disruption Sources.....</i>	<i>14</i>
<i>Power Source Requirements .....</i>	<i>15</i>
<i>Lifting and Handling .....</i>	<i>16</i>
<i>Leveling.....</i>	<i>16</i>
<i>Install the Oven .....</i>	<i>17</i>
<i>Deionized and Distilled Water.....</i>	<i>17</i>
<i>Installation - Clean and Disinfect.....</i>	<i>17</i>
<i>Shelving Installation.....</i>	<i>18</i>
<b>GRAPHIC SYMBOLS .....</b>	<b>19</b>
<b>CONTROL PANEL OVERVIEW .....</b>	<b>21</b>
<b>OPERATION.....</b>	<b>23</b>
<i>Operating Precautions.....</i>	<i>23</i>
<i>Theory of Operation .....</i>	<i>24</i>
<i>Put the Oven into Operation .....</i>	<i>25</i>
<i>Place the Reference Thermometer.....</i>	<i>26</i>
<i>Temperature Matching.....</i>	<i>27</i>
<i>Set the Over Temperature Limit.....</i>	<i>29</i>
<i>Drying Racks and other Accessories.....</i>	<i>30</i>
<b>USER MAINTENANCE.....</b>	<b>31</b>
<i>Cleaning and Disinfecting.....</i>	<i>31</i>
<i>Gaskets and Chamber Integrity.....</i>	<i>32</i>
<i>Electrical Components .....</i>	<i>32</i>
<b>UNIT SPECIFICATIONS .....</b>	<b>33</b>
<i>Weight.....</i>	<i>33</i>
<i>Dimensions.....</i>	<i>33</i>
<i>Capacity .....</i>	<i>33</i>
<i>Shelf Capacity by Weight.....</i>	<i>34</i>
<i>Temperature .....</i>	<i>34</i>
<i>Ventilation Rates .....</i>	<i>35</i>
<i>Power.....</i>	<i>35</i>
<b>PARTS LIST.....</b>	<b>37</b>

# INTRODUCTION

*Thank you for purchasing a SHEL LAB oven. We know you have many choices in today's competitive marketplace when it comes to constant temperature equipment. We appreciate you choosing ours. We stand behind our products and will be here if you need us.*

## ***READ THIS MANUAL***

Failure to follow the guidelines and instructions in this user manual may create a protection impairment by disabling or interfering with the unit safety features. This can result in injury or death.

Before using the unit, read the manual in its entirety to understand how to install, operate, and maintain the unit in a safe manner. Keep this manual available for use by all operators. Ensure all operators are given appropriate training before the unit begins service.

## ***SAFETY CONSIDERATIONS AND REQUIREMENTS***

Follow basic safety precautions, including all national laws, regulations, and local ordinances in your area regarding the use of this unit. If you have any questions about local requirements, please contact the appropriate agencies.

### **SOPs**

Because of the range of potential applications this unit can be used for, the operator or their supervisors must draw up a site-specific standard operating procedure (SOP) covering each application and associated safety guidelines. This SOP must be written and available to all operators in a language they understand.

### **Intended Applications and Locations**

SGO economy gravity ovens are engineered for constant temperature drying, curing, and baking applications in professional, industrial, and educational environments. The ovens are not intended for use at hazardous or household locations.

### **Power**

Your unit and its recommended accessories are designed and tested to meet strict safety requirements.

- The unit is designed to connect to a power source using the specific power cord type shipped with the unit.
- Always plug the unit power cord into a protective earth grounded electrical outlet conforming to national and local electrical codes. If the unit is not grounded properly, parts such as knobs and controls can conduct electricity and cause serious injury.
- Do not bend the power cord excessively, step on it, or place heavy objects on it.
- A damaged cord can be a shock or fire hazard. Never use a power cord if it is damaged or altered in any way.
- Use only approved accessories. Do not modify system components. Any alterations or modifications to your unit not explicitly authorized by the manufacturer can be dangerous and will void your warranty.

## ***CONTACTING ASSISTANCE***

Phone hours for Sheldon Technical Support are 6 am – 4:30 pm Pacific Coast Time (west coast of the United States, UTC -8), Monday - Friday. Please have the following information ready when calling or emailing Technical Support: the **model number** and the **serial number** (see page 11).

EMAIL: [support@sheldonmfg.com](mailto:support@sheldonmfg.com)

PHONE: 1-800-322-4897 extension 4, or (503) 640-3000

FAX: (503) 640-1366

Sheldon Manufacturing, INC.

P.O. Box 627

Cornelius, OR 97113

## ***ENGINEERING IMPROVEMENTS***

Sheldon Manufacturing, Inc. continually improves all of its products. As a result, engineering changes and improvements are made from time to time. Therefore, some changes, modifications, and improvements may not be covered in this manual. If your unit's operating characteristics or appearance differs from those described in this manual, please contact your SHEL LAB dealer or customer service representative for assistance.

# RECEIVING YOUR UNIT

## *INSPECT THE SHIPMENT*

- When a unit leaves the factory, safe delivery becomes the responsibility of the carrier.
- **Damage sustained during transit is not covered by the manufacturing defect warranty.**
- Save the shipping carton until you are certain the unit and its accessories function properly.

When you receive your unit, inspect it for concealed loss or damage to its interior and exterior. If you find any damage to the unit, **follow the carrier's procedure for claiming damage or loss.**

1. Carefully inspect the shipping carton for damage.
2. Report any damage to the carrier service that delivered the unit.
3. If the carton is not damaged, open the carton and remove the contents.
4. Inspect the unit for signs of damage. See the orientation depiction on the next page as a reference.
5. The unit should come with an Installation and Operation Manual.
6. Verify that the correct number of accessory items has been included.
7. Carefully check all packaging for accessory items before discarding.

### Included Accessories

**8 Shelf Clips  
SGO1E**

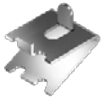

**8 Shelf Clips  
SGO6E**



**1 Power Cord**



**1 Thermometer Clip**



**1 Reference Thermometer**



### Shelves

**SGO1E - 2 Shelves**

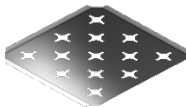

**SGO6E - 2 Shelves**

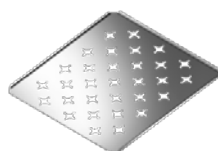

# RECEIVING YOUR UNIT

## ORIENTATION PHOTOS

Figure 1: SGO1E





# RECEIVING YOUR UNIT

Figure 2: SGO6E

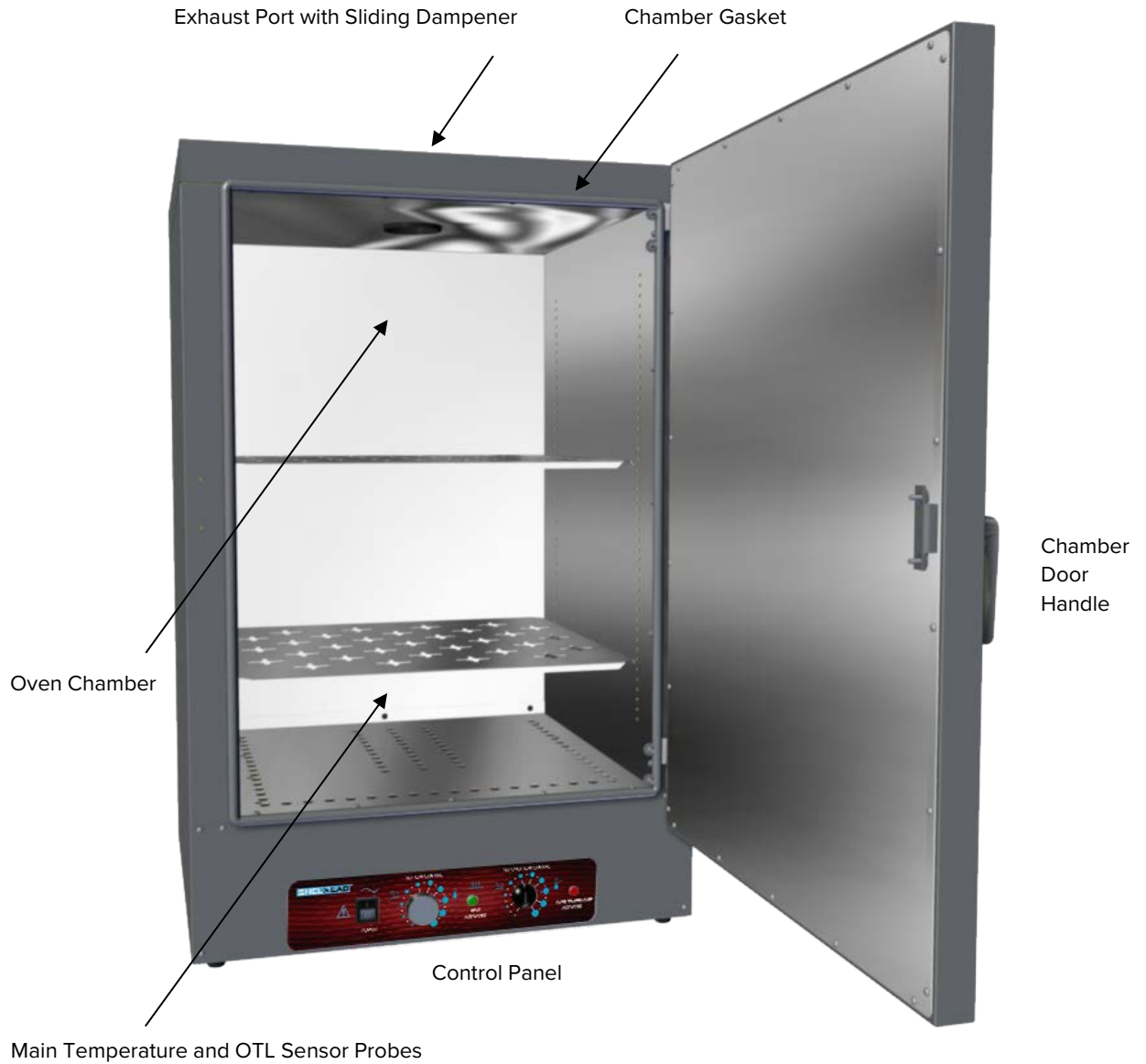

# RECEIVING YOUR UNIT

**Figure 3: Unit Back**



# RECEIVING YOUR UNIT

## *RECORDING DATA PLATE INFORMATION*

The data plate contains the unit **model number** and **serial number**. Tech Support will need this information during any support call. Record it below for future reference.

- The data plate is located on the back of the oven above the power inlet.

Model Number	
Serial Number	

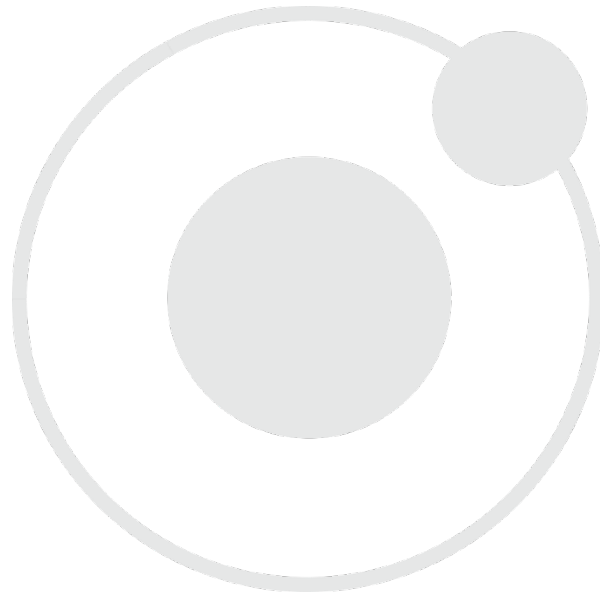

## *INSTALLATION PROCEDURE CHECKLIST*

### **Pre-Installation**

- ✓ Check that the required workspace ambient conditions for the oven are met, page 14.
  - Unit dimensions may be found on page 33
- ✓ Check that the required ventilation and spacing requirements are met, page 14.
- ✓ Check for performance-disrupting heat and cold sources in the environment, page 14.
- ✓ Check that a suitable electrical outlet and power supply is present, page 15.

### **Install the oven in a suitable workspace location**

- ✓ Review the lifting and handling instructions, page 16.
- ✓ Install the oven in its workspace location, page 16.
- ✓ Make sure the oven is level, page 16.

### **Set up the oven for use**

- ✓ Clean the oven chamber and shelving if needed, page 17.
- ✓ Install the shelving in the oven chamber, page 18.

# INSTALLATION

## *REQUIRED AMBIENT CONDITIONS*

This oven is intended for use indoors at room temperatures between **15°C and 40°C (59°F and 104°F)** and at no greater than **80% Relative Humidity** (at 25°C / 77°F). Operating the unit outside of these conditions may adversely affect its temperature range and stability.

## *REQUIRED VENTILATION CLEARANCES*

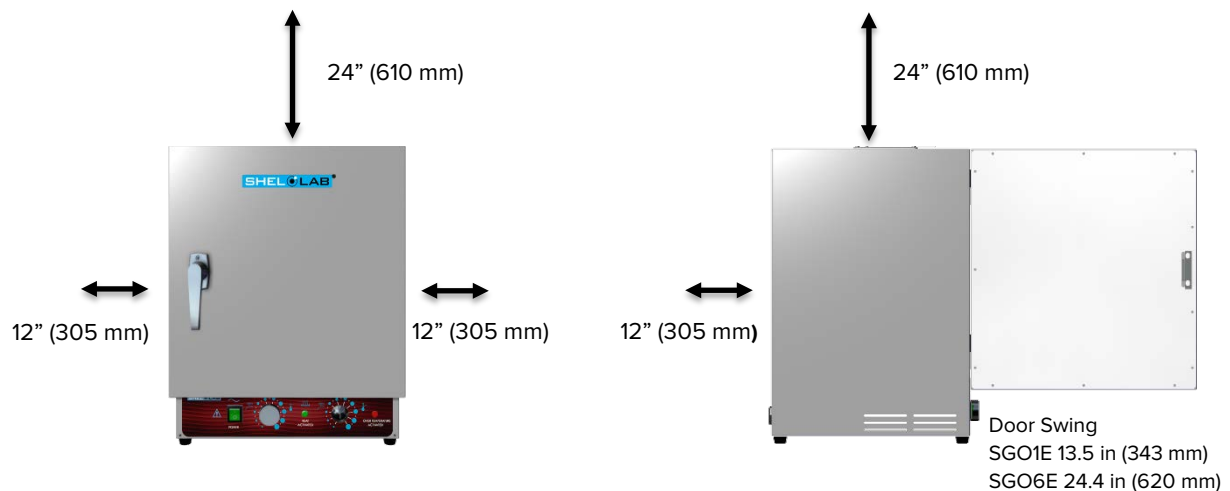

These clearances are required for the oven to operate safely and meet its stated temperature specifications:

- **12 inches (305 mm)** of vertical headspace clearance will suffice if the oven exhaust is vented from the workspace through a duct or other channeling.
  - Otherwise, **24 inches (610 mm)** of headspace clearance is required between the exhaust vent and any overhead cover or partition.
- Do not place objects on top of the oven.

## *ENVIRONMENTAL DISRUPTION SOURCES*

When selecting a location to install the unit, consider all environmental conditions that can affect its temperature performance. For example:

- Proximity to other ovens, autoclaves, and any device that produces significant radiant heat
- Heating and cooling ducts, or other sources of fast-moving air currents
- High-traffic areas
- Direct sunlight

# INSTALLATION

## ***POWER SOURCE REQUIREMENTS***

When selecting a location for the unit, verify that each of the following requirements is satisfied:

**Power Source:** The wall power outlet must meet the power requirements listed on the unit data plate. These units are intended for **110 – 120 VAC 50/60 Hz** applications at the following amperages:

SGO1E	SGO6E
12.0 Amps	14.0 Amps

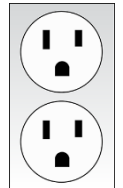

Standard  
NEMA 5-15R  
wall socket

- **Supplied voltage must not vary more than 10% from the data plate rating.** Damage to the unit may result if the supplied voltage varies more than 10%.
- The wall power source must be protective earth grounded.
- Use a separate circuit to prevent loss of the unit due to overloading or circuit failure.
- **The recommended wall circuit breakers for these units are 15 amps.**
- The wall power source must conform to all national and local electrical codes.

### **Power Cord**

The unit must be positioned so that all users can quickly unplug the cord in the event of an emergency.

- Each unit comes provided with a **125 volt, 15Amp, 8ft 2 in (2.5 m) NEMA 5-15P** power cord.
- Always use this cord or an identical replacement.



### **Fuses**

These units ship with a fuse installed in a fuse holder next to the power cord inlet.

- The fuse must be installed and intact for the unit to operate.
- Always find and fix the cause of a blown fuse prior to putting the unit back into operation.
- Fuse type
  - 250V, T6.3, 5X20mm

# INSTALLATION

## ***LIFTING AND HANDLING***

The unit is heavy. Use appropriate lifting devices that are sufficiently rated for the unit weight. Follow the guidelines below when lifting the unit:

- Lift the unit only from its bottom surface.
- Doors, handles, and knobs are not adequate for lifting or stabilization.
- Restrain the unit completely while lifting or transporting so it cannot tip.
- Remove all moving parts, such as shelves and trays, and lock doors in the closed position during transfers to prevent shifting and damage.

## ***LEVELING***

The oven is equipped with non-adjustable rubber feet to raise it off the counter and prevent sliding. Ensure that the oven is placed on a flat and level surface, prior to placing the unit in operation.





## ***INSTALL THE OVEN***

Place the unit in a workspace location that meets the criteria discussed in the previous entries of the Installation section.

## ***DEIONIZED AND DISTILLED WATER***

**Do not use deionized water** to clean the unit. Use of deionized water may corrode metal surfaces and voids the warranty. The manufacturer recommends the use of distilled water in the resistance range of 50K Ohm/cm to 1M Ohm/cm, or a conductivity range of 20.0 uS/cm to 1.0 uS/cm, for cleaning.

## ***INSTALLATION - CLEAN AND DISINFECT***

Cleaning and disinfecting the unit chamber and shelving components now reduces the risk of contamination. The chamber and shelving were cleaned and disinfected at the factory, however, the unit may have been exposed to contaminants during shipping.

- Remove all protective wrappings from shelving components and the ceiling air duct prior to cleaning.
- See the [Cleaning and Disinfecting](#) entry on page 31 for information on how to clean and disinfect without damaging the unit or its components.

# INSTALLATION

## *SHELVING INSTALLATION*

1. Install 4 clips for each shelf in the slots located on the sides of the chamber interior.
  - a. Squeeze each clip.
  - b. Insert the top tabs first, then the bottom tabs using a rocking motion.
2. Place the shelf on the clips.

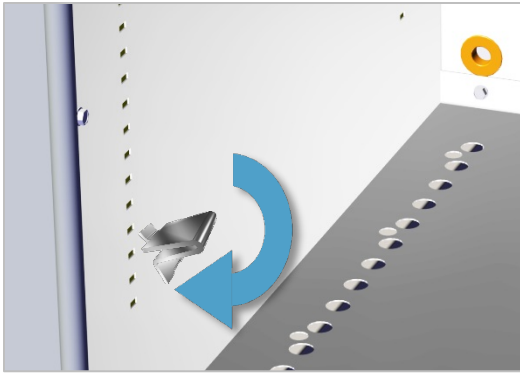



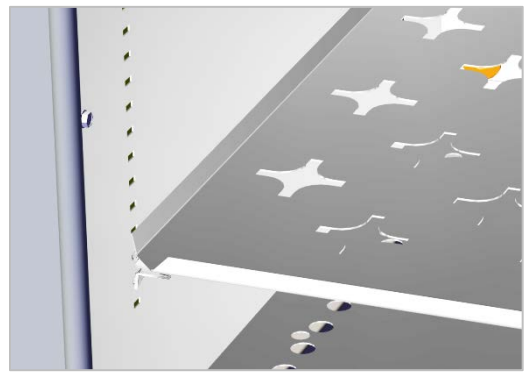







**Figure 5: Install 4 Clips**

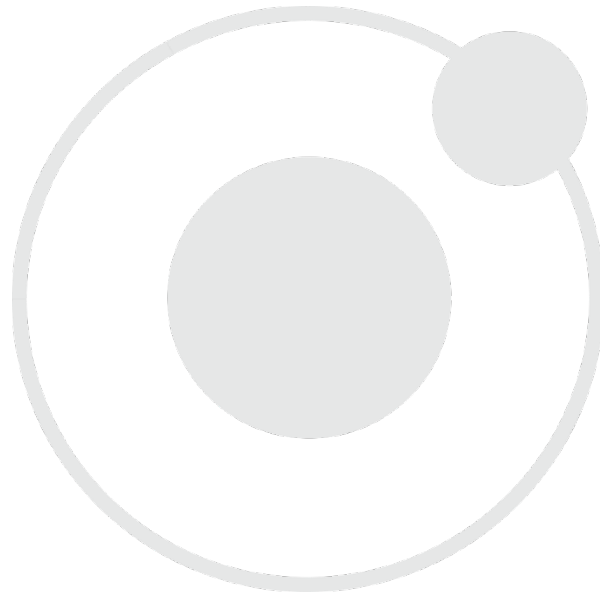

**Figure 4: Place the Shelf**

# GRAPHIC SYMBOLS

The unit is provided with multiple graphic symbols on its exterior. The symbols identify hazards and the functions of the adjustable components, as well as important notes in the user manual.

Symbol	Definition
	Consult the user manual Consulter le manuel d'utilisation
	Temperature display Indique l'affichage de la température
	Over Temperature Limit system Thermostat température limite contrôle haute
	AC Power Repère le courant alternatif
	I/ON O/OFF I indique que l'interrupteur est en position marche. O indique que le commutateur est en position d'arrêt.
	Protective earth ground Terre électrique
	Manually adjustable Indique un réglage manuel
	Recycle the unit. Do not dispose of in a landfill. Recycle l'unité. Ne jetez pas dans une décharge.
	Caution hot surface Attention surface chaude
	Indicates the oven is heating Le four chauffe



# CONTROL PANEL OVERVIEW

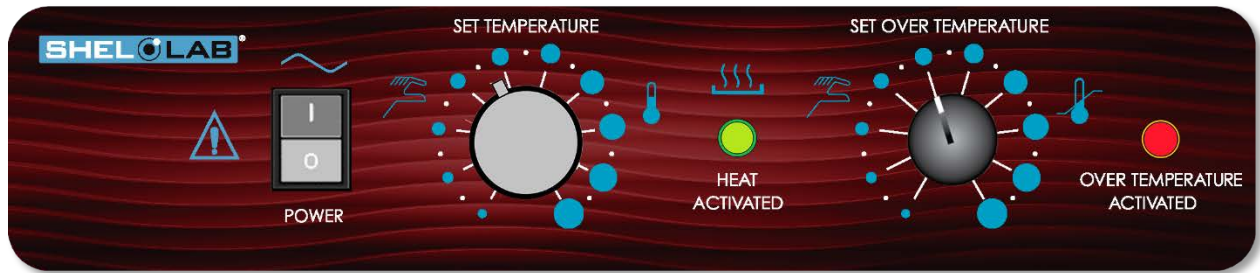

Control Panel

## Power Switch

Power is supplied when the switch is in the ( I ) ON position.



## Set Temperature Controller

This graduated dial sets the oven operating temperature. The dial is marked with 10 major increments and 9 minor increments, which can be used as index points for setting and returning to temperature levels.



## Heating Activated Light

The green light located beneath the label HEATING ACTIVATED illuminates whenever the oven element is being powered to heat the chamber.



## Set Over Temperature

This graduated dial sets the temperature cutoff limit for the Over Temperature Limit system. The OTL is an independent mechanical heating cutoff that prevents unchecked heating of the oven in the event of a failure of the main temperature controller system. For more details, please see the explanation of the [Over Temperature Limit System](#) on page 24 in the Theory of Operation entry.



## Over Temperature Activated Light

Illuminates whenever the OTL system is routing power away from the heating elements. Under normal operating conditions this light should remain off.



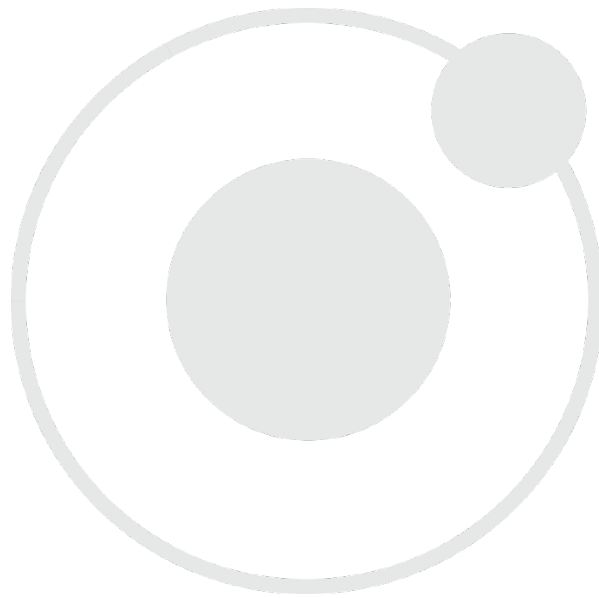

Safe operation of the unit is dependent on the actions and behavior of the unit operators. **Operating personnel must read and understand the Operating Precautions in this section prior to operating the unit.** The operators must follow these instructions to prevent injuries and to safeguard their health, environment, and the materials being treated in the unit, as well as to prevent damage to the unit. Failure to adhere to the Safety Guidelines and Operating Cautions, deliberately or through error, is a hazardous behavior on the part of the operator.



Le fonctionnement sûr du four dépend des actions et du comportement des opérateurs du four. Le personnel d'exploitation doit lire et comprendre les consignes de sécurité et les précautions d'utilisation de cette section avant d'utiliser le four. Les opérateurs doivent suivre ces instructions pour prévenir les blessures et protéger leur santé, leur environnement et les matériaux traités dans le four, ainsi que pour éviter d'endommager le four. Le non-respect des consignes de sécurité et des précautions d'utilisation, délibérément ou par erreur, est un comportement dangereux de la part de l'opérateur.



## ***OPERATING PRECAUTIONS***

- Do not use this oven in unsafe improper applications that produce flammable or combustible gases, vapors, liquids, or fuel-air mixtures in quantities that can become potentially explosive.
- Outgassed byproducts may be hazardous to or noxious for operating personnel. Exhaust should be vented to a location outside the workspace in a safe manner in accordance with all applicable laws, ordinances, and regulations. Do not operate the oven in an unsafe area with noxious fumes.
- Do not use this oven for applications heating hazardous fibers or dust. These items can become airborne and come into contact with hot surfaces.
- Individual ovens are not rated to be explosion proof. Follow all building certification requirements and laws for Class I, II, or III locations as defined by the US National Electric Code.
- The bottom surface of the chamber should not be used as a work surface. It runs hotter than the shelf temperatures. Never place samples or product on the oven chamber floor.
- Do not place sealed or filled containers in the oven. These may burst open when heated.
- Do not place alcohol or mercury thermometers in the oven. These devices may rupture under heat or other improper uses.
- Do not move the oven until it has finished cooling.

---

**Warning:** The vent dampers may be hot to the touch. These areas are marked with Hot Surface labels. Proper PPE should be employed to minimize risk to burn.

**Avertissement:** Les clapets d'aération peuvent être chauds au toucher. Ces zones sont marqués avec des étiquettes de Surface chaude. Les EPI approprié devraient être employée pour réduire au minimum le risque de brûler.

---



# OPERATION

## *THEORY OF OPERATION*

### Heating



When powered, the SGOE oven chamber heats to the current control setting level and then maintains that temperature level. The control thermostat monitors the chamber air temperature via a hydrostatic probe located on the rear wall of the oven chamber. When the probe registers that the chamber temperature has dropped below the control setting, it powers the heating element, then cuts off when the temperature has been achieved.

SGOE ovens rely on natural heat radiation for cooling. When the oven is powered, the chamber air temperature cannot go below the ambient room temperature plus the internal waste heat generated by the oven.

### Air Circulation and Venting



The oven is provided with a dampener vent that may be opened or closed using a dampener slide located on the oven top. SGOE ovens must be run with the dampener 30% open in order to achieve the stated temperature performance specifications. Temperature Uniformity is achieved through cold air entering the chamber, falling, then being heated and rising to the chamber top in a gravity convection cycle.

Opening the vent all the way during a baking application may speed the rate of material drying, depending on the nature of your application. However, it also introduces excessive quantities of cool air into the chamber while allowing heated air to exit. This will likely impact the temperature performance of the oven. For most applications, fully opening the vent after the baking portion of the application will help to speed product or sample drying.

### The Over Temperature Limit System (OTL)



When set, the mechanical OTL heating cutoff system prevents runaway heating in the oven chamber. The OTL operates independently of the microprocessor and is provided with a separate, hydrostatic temperature sensor probe located in the oven chamber. In the event the chamber air temperature exceeds the current OTL setting, the OTL routes power away from the heating elements. The OTL will continue to prevent heating until the temperature drops below its limit setting. The Over Temperature Limit is set by the end-user, typically at approximately 5°C above the oven chamber temperature.



# OPERATION

**Note:** The oven may produce light smoking during its first use above 150°C as the remnants of a protective oil coating burn off the heating element.

## *PUT THE OVEN INTO OPERATION*

Carry out the following steps and procedures to put the oven into operation after installing it in a new workspace environment.



### 1. Plug in the power cord



Attach the power cord that came with the unit to the power inlet receptacle on the back of the oven.

Plug the power cord into the workspace electrical supply outlet.

### 2. Power the oven



Place the oven **Power Switch** in the ON ( I ) position.

The switch and Temperature display will both illuminate.

### 3. Prepare the Oven for Temperature Matching



See the [Placing the Reference Thermometer](#) procedure on page 26.

### 4. Match the Oven Temperature to your Application Target

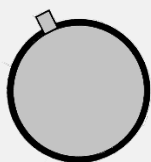

See the [Temperature Matching](#) procedure on page 27.

### 5. Set the Over Temperature Limit

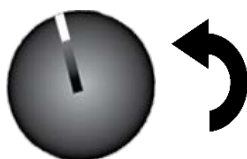

See the [Set the Over Temperature Limit](#) on page 29.

- The oven must be heated and stable at your application temperature prior to performing this procedure.

End of procedure

# OPERATION

## *PLACE THE REFERENCE THERMOMETER*

1. Loosen the 4 nuts attaching the exhaust port cover.

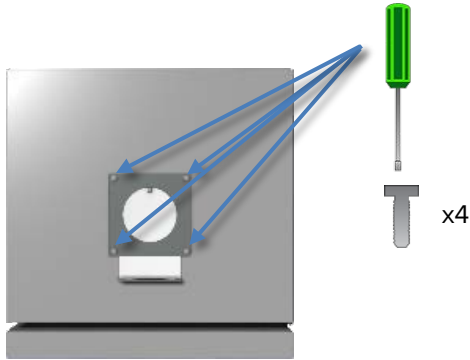

2. Slide Clip between top cover and unit body

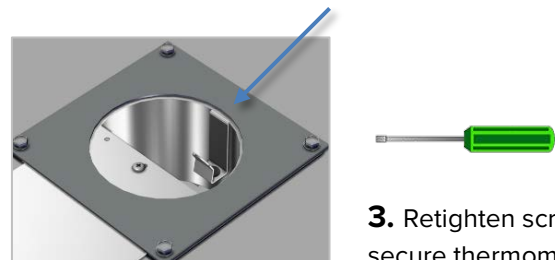

3. Retighten screws to secure thermometer clip

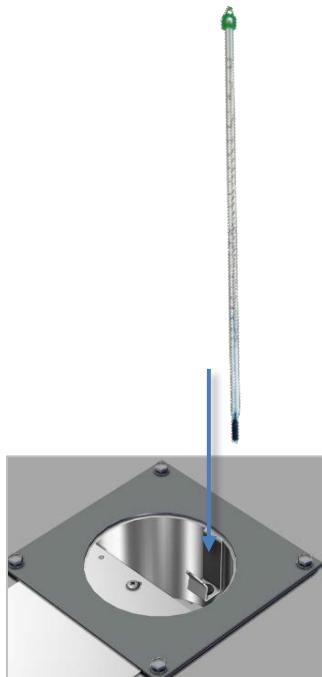

4. Insert thermometer in clip so that approximately 1/3 of the thermometer is inside the oven chamber

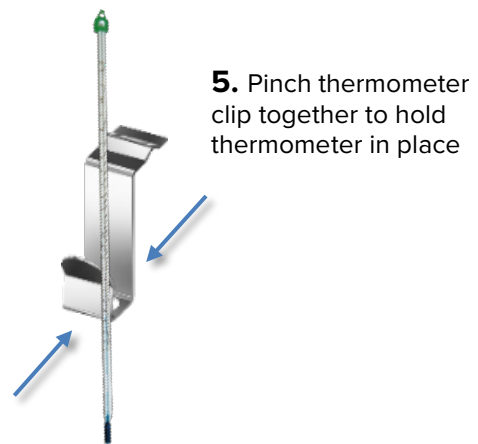

5. Pinch thermometer clip together to hold thermometer in place

---

**Note:** The reference thermometer is fragile. Use caution when pinching the thermometer clip and when adjusting the dampener slide.

---

# OPERATION

## TEMPERATURE MATCHING

Match the oven chamber temperature to your application target.



**1. Turn the OTL dial clockwise to its maximum position, if not already set to max.**

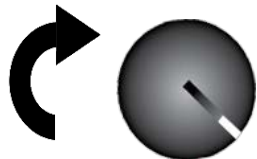

This prevents the over temperature heating cutoff system from interfering with this procedure.

**2. Set the vent to 30% Open**



- The vent must be partly open to create convection and temperature mixing in the oven chamber.
- The oven will not achieve its specified temperature uniformity if the vent is closed or if it is fully open.

**3. Set the Approximate Oven Temperature**

Turn the Main Temperature control to the approximate position for your application:

Controller Position	Approximate Temperature	Controller Position	Approximate Temperature
	40-50°C*		130-140°C
	58-68°C		148-158°C
	76-86°C		166-176°C
	94-104°C		184-194°C
	112-122°C		195 - 202°C*

\*The achievable low- and high-end operating temperatures are partly dependent on the ambient room temperature.

Continued on next page

# OPERATION

## Temperature Matching (continued)



**Note:** The exhaust port is hot and thermometer will quickly heat up when inserted. Always use PPE when handling reference thermometer.

**Note:** L'orifice d'échappement est chaud et le thermomètre chauffe rapidement lorsqu'il est inséré. Utilisez toujours un EPI lorsque vous manipulez un thermomètre de référence.



4.

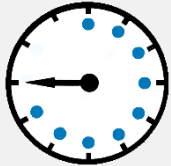

Wait 45 minutes for oven chamber temperature to stabilize.

### 5. Verify the Oven Temperature



Use the reference thermometer included with the oven to check the oven temperature.

**Optional:** A digital reference device may be used to match the unit temperature.

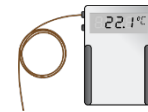

### 6. Check the Thermometer Temperature

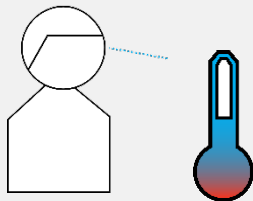

- If the thermometer temperature matches your application temperature or is close enough, the temperature matching procedure is now complete.

Record the controller dial position and then remove the reference thermometer.

**-OR-**

- See the next step if the difference falls outside the acceptable range of your application.

### 7. Adjust Temperature Dial

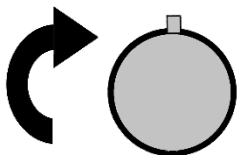

- a) Verify the dampener is open 30% and that there are no external heat or cold sources affecting oven stability.
- b) Adjust the temperature dial up or down and wait 20 minutes before re-checking reference thermometer.

If the oven fails to achieve your application temperature in 5 attempts, contact Technical Support.

End of Procedure

# OPERATION

**Note:** Test the OTL system at least once per year to verify its functionality

## SET THE OVER TEMPERATURE LIMIT

This procedure sets the Over Temperature Limit heating cutoff to approximately 5°C above the current chamber temperature. **Perform this procedure when the oven has been running with no temperature fluctuations at your application temperature for at least 30 minutes.**



**1. Set OTL control to its maximum setting, if not already set to max.**

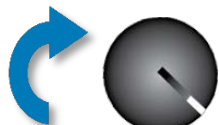

**2. Turn the dial counterclockwise until the red Over Temperature Limit Light illuminates.**



**3. Slowly turn the dial clockwise until the OTL Activated light turns off.**



- The manufacturer recommends turning the dial two minor scale divisions to the right
- The Over Temperature Limit is now set approximately 5°C above the current oven chamber air temperature.

**4. Leave the OTL dial set just above the activation point.**



**Optional: Turn the dial slightly to the left.**



- This sets the OTL cutoff threshold nearer to the current chamber air temperature.

If the OTL sporadically activates after setting the control, turn the dial very slightly to the right (clockwise).

If the OTL continues activating, check for ambient sources of heat or cold that may be adversely impacting the unit temperature stability. If you find no sources of external or internal temperature fluctuations, contact [Tech Support](#) or your distributor for assistance.

End of procedure

## ***DRYING RACKS AND OTHER ACCESSORIES***

Make sure that any accessories used inside the oven chamber, such as drying racks, are suitable for your application and will not suffer damage when brought to temperature. Always set the OTL cutoff system to approximately 5°C above your application temperature in order to safeguard accessories against over temperature events. The manufacturing defect warranty does not cover damage caused by melted or otherwise overheated accessory items.

---

**Warning:** Disconnect this unit from its power source prior to maintenance or service.

**Avertissement:** Avant d'effectuer toute maintenance ou entretien de cet appareil, débrancher le cordon secteur de la source d'alimentation.

---



## ***CLEANING AND DISINFECTING***

If a hazardous material or substance has spilled in the unit, immediately initiate your site's Hazardous Material Spill Containment protocol. Contact your local Site Safety Officer and follow instructions per the site policy and procedures.

- The unit chamber should be cleaned prior to first use.
- Periodic cleaning is required.
- Do not use spray on cleaners or disinfectants. These can leak through openings and coat electrical components.
- Consult with the manufacturer or their agent if you have any doubts about the compatibility of decontamination or cleaning agents with the parts of the equipment or with the material contained in it.
- Do not use cleaners or disinfectants that contain solvents capable of harming paint coatings or stainless steel surfaces. **Do not use chlorine-based bleaches or abrasives; these will damage the chamber liner.**

---

**Warning:** Exercise caution if cleaning the unit with alcohol or flammable cleaners. Always allow the unit to cool down to room temperature prior to cleaning and make sure all cleaning agents have evaporated or otherwise been completely removed prior to putting the unit back into service.

**Avertissement:** Soyez prudent lorsque vous nettoyez l'appareil avec de l'alcool ou des produits de nettoyage inflammables. Laissez toujours refroidir l'appareil à la température ambiante avant le nettoyage et assurez-vous que tous les produits de nettoyage se sont évaporés ou ont été complètement enlevés avant de remettre l'appareil en service.

---



### **Cleaning**

1. Disconnect the unit from its power supply.
2. Remove all removable interior components such as shelving and accessories.
3. Clean the unit with a mild soap and water solution, including all corners.
  - **Do not use an abrasive cleaner;** these will damage metal surfaces.
  - **Do not use deionized water to rinse or clean with.**
  - Take special care when cleaning around the temperature sensor probes in the chamber to prevent damage. Do not clean the probes.
4. Rinse with distilled water and wipe dry with a soft cloth.

## Disinfecting

Disinfect the oven if algae, mold, bacteria, or other biological contaminants are an issue. For maximum effectiveness, disinfection procedures are typically performed after cleaning.

Keep the following points in mind when disinfecting the unit:

- Turn off and unplug the unit to safeguard against electrical hazards.
- Disinfect the unit chamber using commercially available disinfectants that are non-corrosive, non-abrasive, and suitable for use on stainless steel and glass surfaces. Contact your local Site Safety Officer for detailed information on which disinfectants are compatible with your applications.
- If permitted by your protocol, remove all removable interior accessories (shelving and other non-attached items) from the chamber when disinfecting.
- Disinfect all surfaces in the chamber, making sure to thoroughly disinfect the corners. Exercise care to avoid damaging the sensor probes.
- When disinfecting external surfaces, use disinfectants that will not damage painted metal, glass, and plastic.

## ***GASKETS AND CHAMBER INTEGRITY***

Periodically, inspect the door latch, trim, catch, and the gasket for signs of deterioration. Failure to maintain the integrity of the door system shortens the life span of the oven.

## ***ELECTRICAL COMPONENTS***

Electrical components do not require maintenance. If the unit fails to operate as specified, please contact your SHEL LAB distributor or Technical Support for assistance.



# UNIT SPECIFICATIONS

These ovens are 110 - 120 volt units. Please refer to the oven data plate for individual electrical specifications.

Technical data specified applies to units with standard equipment at an ambient temperature of 25°C and at nominal voltage. The temperatures specified are determined in accordance to factory standard following DIN 12880 respecting the recommended wall clearances of 10% of the height, width, and depth of the inner chamber. All indications are average values, typical for units produced in the series. We reserve the right to alter technical specifications at all times.

## ***WEIGHT***

Model	Shipping Weight	Net Weight
SGO1E	53 lbs. / 23 kg	38.0 lbs / 17.3 kg
SGO6E	145 lbs. / 21 kg	208.0 lbs / 94.3 kg

## ***DIMENSIONS***

### **By Inches**

Model	Exterior W × D × H	Interior W × D × H
SGO1E	13.5 x 18.5 x 21.3 in	11.7 x 12.0 x 12.0 in
SGO6E	24.4 x 25.0 x 37.5 in	19.9 x 19.4 x 28.0 in

### **By Millimeters**

Model	Exterior W × D × H	Interior W × D × H
SGO1E	343 x 470 x 541 mm	299 x 305 x 305 mm
SGO6E	620 x 635 x 954 mm	507 x 494 x 710 mm

## ***CAPACITY***

Model	Cubic Feet	Liters
SGO1E	1.0	27.7
SGO6E	4.9	138.0

# UNIT SPECIFICATIONS

## *SHELF CAPACITY BY WEIGHT*

Model	Per Shelf	Max Total Load	Max No. Shelves
SGO1E	35.0 lbs. / 15.9 kg*	70.0 lbs. / 31.6 kg**	4 Shelves
SGO6E	35.0 lbs. / 15.9 kg*	105.0 lbs. / 47.6 kg***	9 Shelves

\*35.0 lbs/15.9kg with weight evenly distributed across the shelf.

\*\*70.0 lbs/31.6kg total load for the SGO1E shelves. Exceeding this limit risks damaging the chamber liner.

\*\*\*105.0 lbs/47.6kg total load for the SGO6E shelves. Exceeding this limit risks damaging the chamber liner.

## *TEMPERATURE*

### Range and Stability

Model	Operating Range	Stability
SGO1E	Ambient +20 to 200°C	± 0.2°C @100°C
SGO6E	Ambient +20 to 200°C	± 0.3°C @100°C

### Uniformity

Model	Uniformity @50°C	Uniformity @100°C	Uniformity @200°C
SGO1E	± 1.0°C	± 2.3°C	± 4.7°C
SGO6E	± 0.75°C	± 1.8°C	± 4.5°C

**Time to Temperature:** From an ambient temperature of 20°C.

Model	Heat Up to 50°C	Heat Up to 100°C	Heat Up to 200°C
SGO1E	8 Minutes	20 Minutes	52 Minutes
SGO6E	9 Minutes	28 Minutes	130 Minutes

Temperature continued on next page

# UNIT SPECIFICATIONS

**Recovery Time:** From a 30-second door opening.

Model	Recovery to 50°C	Recovery to 100°	Recovery to 200°C
SGO1E	1.5 Minutes	4.5 Minutes	14.0 Minutes
SGO6E	2.0 Minutes	4.0 Minutes	45.0 Minutes

**Recovery Time:** From a 60-second door opening.

Model	Recovery to 50°C	Recovery to 100°	Recovery to 200°C
SGO1E	4.0 Minutes	6.0 Minutes	20.0 Minutes
SGO6E	3.5 Minutes	6.0 Minutes	57.0 Minutes

## *VENTILATION RATES*

**Velocity**

Model	Cubic Feet / Minute @50°C	Liters per Minute @50°C
SGO1E	5.3	150
SGO6E	15.2	430

**Air Changes per Hour**





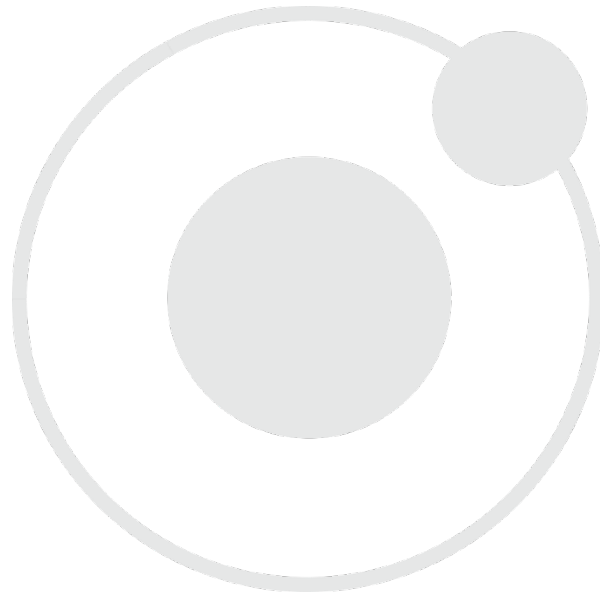

Model	@50°C
SGO1E	330
SGO6E	180

## *POWER*

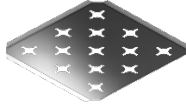
Model	AC Voltage	Amperage	Frequency
SGO1E	110 - 120	12.0	50/60 Hz
SGO6E	110 - 120	14.0	50/60 Hz

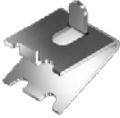

# PARTS LIST

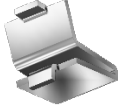
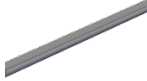
Description	Parts Number	Description	Parts Number
Reference Thermometer Clip	 <b>5080865</b>	Shelf, SGO1E	 <b>5080538</b>
Reference Thermometer	 <b>8200509</b>	Shelf, SGO6E	 <b>5130714</b>
Fuse, T6.3A 250V 5x20mm	 <b>3300515</b>	Shelf Clip, Individual (1) SGO1E	 <b>1250512</b>
Power Cord 125 volt, 15Amp, 8 ft 2 in (2.5 m) NEMA 5-15P	 <b>1800510</b>	Shelf Clip, Individual (1) SGO6E	 <b>1250511</b>
Silicone Door Gasket. Sold by the foot. SGO1E requires 4.8 ft; SGO6E requires 8.3 ft	 <b>3450722</b>		

## Ordering

If you have the Part Number for an item, you may order it directly from the manufacturer by calling 1-800-322-4897 extension 3. If you are uncertain that you have the correct Part Number, or if you need that specific item, please contact Sheldon Technical Support for help at 1-800-322-4897 extension 4 or (503) 640-3000. Please have the **model number** and **serial number** of the unit ready, as Tech Support will need this information to match your unit to its correct part.



**SHELDON**  
MANUFACTURING, INC

P.O. Box 627  
Cornelius, OR 97113  
USA

[support@sheldonmfg.com](mailto:support@sheldonmfg.com)  
[sheldonmanufacturing.com](http://sheldonmanufacturing.com)

1-800-322-4897  
(503) 640-3000  
FAX: 503 640-1366