



Installation - Operation Manual

Peltier Bead Baths – 75400-707 and 75400-714

On the front cover, left to right: 75400-707 (7-liter bead bath) and 75400-714 (14-liter bead bath)

These bead baths require the use of Lab Armor beads to function properly. The units are not watertight and cannot be used as water baths.

Ambient conditions impacting chilling.

75400-707: Sustained environmental temperatures of 23.5°C to 30°C (74.3°F to 86°F) can impact the ability of the 7-liter bead bath to hold chilling temperatures near the bottom of its operating range. To achieve the best low-end operating bath temperature, this model should be installed in a workspace with ambient temperatures from 15°C to 23.4°C (59°F to 74°F). See page 48 for more information.

75400-714: Sustained environmental temperatures of 25.5°C to 30°C (78°F to 86°F) can impact the ability of the 14-liter bead bath to hold chilling temperatures at and near the bottom of its operating range. To achieve the best low-end operating bath temperature, this model should be installed in a workspace with ambient temperatures from 15°C to 25.4°C (59°F to 77.7°F). See page 48 for more information.

Warning: This product contains chemicals, including triglycidyl isocyanurate, known to the State of California to cause cancer as well as birth defects or other reproductive harm. For more information, go to www.P65Warnings.ca.gov.



¡Advertencia! Este producto contiene sustancias químicas, incluido el triglicidil isocianurato, que el Estado de California sabe que causa cáncer, así como defectos de nacimiento u otros daños reproductivos. Para obtener más información, visite www.P65Warnings.ca.gov.

Avertissement! Ce produit peut vous exposer à des produits chimiques, dont l'isocyanurate de triglycidyle, reconnu par l'État de Californie pour provoquer le cancer, des anomalies congénitales ou d'autres problèmes de reproduction. Pour plus d'informations, visitez le site www.P65Warnings.ca.gov.

Lab Armor Peltier Chilling Bead Baths

100 – 240 Voltage

Part Number (Manual): 4861844

Revision: August 25, 2021

TABLE OF CONTENTS

CERTIFICATIONS	5
<i>Safety.....</i>	5
<i>ISO Certified Manufacturer.....</i>	5
INTRODUCTION	7
<i>Read this Manual.....</i>	7
<i>Safety Considerations and Requirements</i>	7
<i>Contacting Assistance</i>	8
<i>Manufacturing Warranty.....</i>	8
<i>Engineering Improvements.....</i>	8
<i>Lab Armor Beads Required.....</i>	9
<i>Reference Sensor Device</i>	10
RECEIVING YOUR UNIT	11
<i>Inspect the Shipment.....</i>	11
<i>Orientation Images</i>	12
<i>Record the Data Plate Information.....</i>	16
INSTALLATION	17
<i>Installation Procedure Checklist</i>	17
<i>Required Ambient Conditions.....</i>	18
<i>Required Clearances.....</i>	19
<i>Power Source Requirements</i>	20
<i>Lifting and Handling</i>	21
<i>Leveling.....</i>	21
<i>Install the Bead Bath</i>	21
<i>Deionized and Distilled Water.....</i>	22
<i>Installation Cleaning and Disinfecting</i>	22
GRAPHIC SYMBOLS	23
CONTROL OVERVIEW	25
OPERATION.....	27
<i>Theory of Operation</i>	27
<i>Put the Bead Bath into Operation</i>	29
<i>Fill With Lab Armor Beads</i>	31
<i>Set the Temperature Setpoint.....</i>	33
<i>Set the Over Temperature Limit (OTL)</i>	34
<i>Loading Samples.....</i>	35
<i>Process Transition from Water Baths.....</i>	36
USER MAINTENANCE.....	37
<i>Cleaning and Disinfecting the Bath</i>	37
<i>Cleaning and Disinfecting Lab Armor Beads.....</i>	38
<i>Minimizing Contamination Exposure</i>	39
<i>Electrical Components.....</i>	39
<i>Safety After Repairs and Maintenance.....</i>	40
<i>Moving or Storing the Bead Bath</i>	40
<i>Calibrate the Temperature Display.....</i>	41
UNIT SPECIFICATIONS	47
<i>Weight.....</i>	47
<i>Dimensions.....</i>	47
<i>Capacity</i>	48
<i>Temperature</i>	48
<i>Power.....</i>	49
PARTS AND ACCESSORIES	51
<i>Parts</i>	51
<i>Accessories.....</i>	52

CERTIFICATIONS

SAFETY

Certifications and compliance statements.

IEC 61010 Safety Certified: Canada, USA, European Union

These unit models are certified by Intertek as compliant with the International Electrotechnical Commission's 61010 safety standards for electrical, mechanical, and fire hazards.

Conforms to UL Standards

61010-1:2012/AMD1:2016
61010-2-010:2019

Certified to CSA Standards

C22.2 #61010-1-12:2012
C22.2 #61010-2-010:2019

Certified to EN Standards

61010-1:2010
61010-2-010:2015

Intertek is an OSHA-recognized NRTL, a Standards Council of Canada accredited certification body, and an EU Notified Body.



5019746

CE Compliant

These unit models meet all required electromagnetic compatibility (EMC), EU low-voltage, and RoHS safety directives.



ISO CERTIFIED MANUFACTURER

These models are manufactured for Lab Armor by Sheldon Manufacturing, INC, an ISO-certified manufacturer.





INTRODUCTION

Thank you for purchasing a Lab Armor Peltier bead bath. We know you have many choices in today's competitive marketplace when it comes to constant temperature equipment. We appreciate you choosing ours. We stand behind our products and will be here for you if you need us.

READ THIS MANUAL

Failure to follow the guidelines and instructions in this user manual may create a protection impairment by disabling or interfering with the unit safety features. This can result in injury or death.

Before using the unit, read the manual in its entirety to understand how to install, operate, and maintain the unit in a safe manner. Ensure all operators are given appropriate training before the unit begins service.

Keep this manual available for use by all operators.

SAFETY CONSIDERATIONS AND REQUIREMENTS

Safety: Follow basic safety precautions, including all national laws, regulations, and local ordinances in your area regarding the use of this unit. If you have any questions about local requirements, please contact the appropriate agencies.

SOPs: Because of the range of potential applications this unit can be used for, the operator or their supervisors must draw up a site-specific standard operating procedure (SOP) covering each application and associated safety guidelines. This SOP must be written and available to all operators in a language they understand.

Intended Applications and Locations: These Peltier bead baths are intended for constant temperature, general-purpose chilling, and warming applications in professional, industrial, and educational environments. The units are not intended for use at hazardous or household locations.

Power: Your unit and its recommended accessories are designed and tested to meet strict safety requirements.

- The unit is designed to connect to a power source using the specific power cord type shipped with the unit.
- Always plug the unit power cord into a protective earth grounded electrical outlet conforming to national and local electrical codes. If the unit is not grounded properly, parts such as knobs and controls can conduct electricity and cause serious injury.
- Do not bend the power cord excessively, step on it, or place heavy objects on it.
- A damaged cord can be a shock or fire hazard. Never use a power cord if it is damaged or altered in any way.
- Use only approved accessories. Do not modify system components. Any alterations or modifications to your unit not explicitly authorized by the manufacturer can be dangerous and are not covered by the manufacturing defect warranty.

CONTACTING ASSISTANCE

Phone hours for Customer Support are 6 am – 4:30 pm Pacific Coast Time (west coast of the United States, UTC -8), Monday – Friday. Please have the following information ready when calling or emailing Customer Support: the **model number**, **serial number**, and **part number** (see page 16).

support@labarmor.com

1-469-496-2350

FAX: 1-833-257-1475

Lab Armor LLC

4001 East Plano Parkway Ste 200

Plano TX 75074

USA

MANUFACTURING WARRANTY

For information on your warranty and online warranty registration please visit:

<https://www.labarmor.com/lab-armor-warranty-policy/>

ENGINEERING IMPROVEMENTS

Lab Armor continually improves all of its products. As a result, engineering changes and improvements are made from time to time. Therefore, some changes, modifications, and improvements may not be covered in this manual. If your unit's operating characteristics or appearance differs from those described in this manual, please contact your Lab Armor dealer or customer service representative for assistance.

INTRODUCTION

LAB ARMOR BEADS REQUIRED

These baths must be filled with beads to the specified level to function. Lab Armor aluminum-coated beads are designed to maximize thermal conductivity while allowing ease of placement for samples.

The unit cannot operate as a water or oil bath.

Each bead bath unit requires a sufficient volume of beads to fill it to **1" (25 mm)** below the top of the basket. This level helps hold laboratory vessels in place while providing optimal temperature stability and uniformity.

74500-714s: These 14-liter bath units require bead-filled baskets in both wells for the bath to function properly. The baskets must occupy the entirety of the well-space. Leaving a basket well empty or partially empty will adversely impact temperature performance.

Recommended Volume of Beads

Model	Bead Volume
75400-707	5 liters
75400-714	10 liters

See page 50 for ordering information.

Bead baths and traditional water baths have slight operational differences. See page 36 for a more detailed explanation.



REFERENCE SENSOR DEVICE

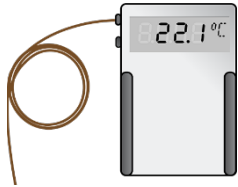

Temperature Calibrations

A temperature reference sensor device is required if you are not using a third-party outside service to calibrate the bath's temperature display. The display must be calibrated every time a new temperature setpoint is set.

- See the [Calibrating the Temperature Display](#) procedure on page 41 for more information.

The device must be purchased separately.

Device Accuracy

Reference devices must meet the following standards:

- Accurate to at least 0.1°C

The device should be regularly calibrated, preferably by a third party.

Temperature Probes

Use a digital device with a wire thermocouple probe. Select a thermocouple suitable for the application temperature you will be calibrating at.

Why Probes?

Reference readings taken from outside the unit using wire temperature probes avoid lid openings, which disrupt the unit temperature. Each disruption requires **a minimum 1-hour wait** to allow the temperature to re-stabilize before continuing.

No Alcohol or Mercury Thermometers

Alcohol thermometers do not have sufficient accuracy to conduct accurate temperature calibrations. **Never place a mercury thermometer in the unit.** Always use thermocouple probes.

RECEIVING YOUR UNIT





INSPECT THE SHIPMENT

Safe delivery becomes the responsibility of the carrier when a unit leaves the factory. **Damage sustained during transit is not covered by the manufacturing defect warranty.**

When you receive your unit, inspect it for concealed loss or damage to its interior and exterior. If you find any damage to the unit, **follow the carrier's procedure for claiming damage or loss.** Save the shipping carton until you are certain that the unit and its accessories function properly.

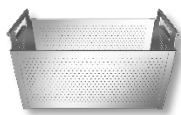
1. Carefully inspect the shipping carton for damage.
2. Report any damage to the carrier service that delivered the unit.
3. If the carton is not damaged, open the carton and remove the contents.
4. Inspect the unit for signs of damage. Use the orientation images in this chapter as references.
5. The unit should come with an Installation and Operation Manual.
6. Verify that the correct number of accessory items has been included.
7. Carefully check all packaging for accessory items before discarding.

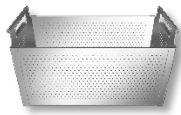
Included Accessories

Model	Removable Bead Basket	Power Cord, NEMA	Power Cord, EUR
75400-707	1	1	1
			
75400-714	2	1	1
			

ORIENTATION IMAGES

75400-714 (14 Liter Bath)

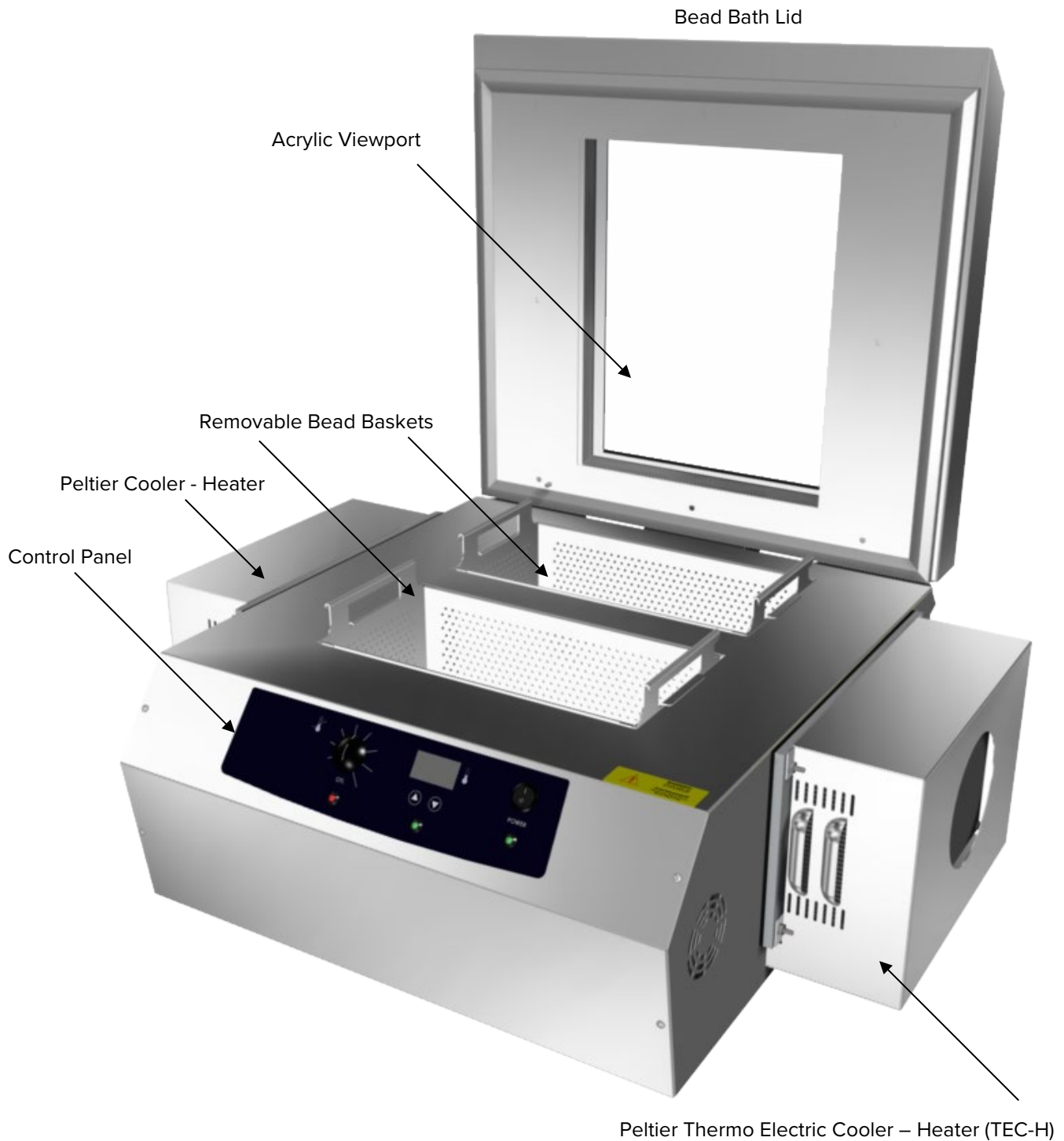

RECEIVING

Back, 75400-714

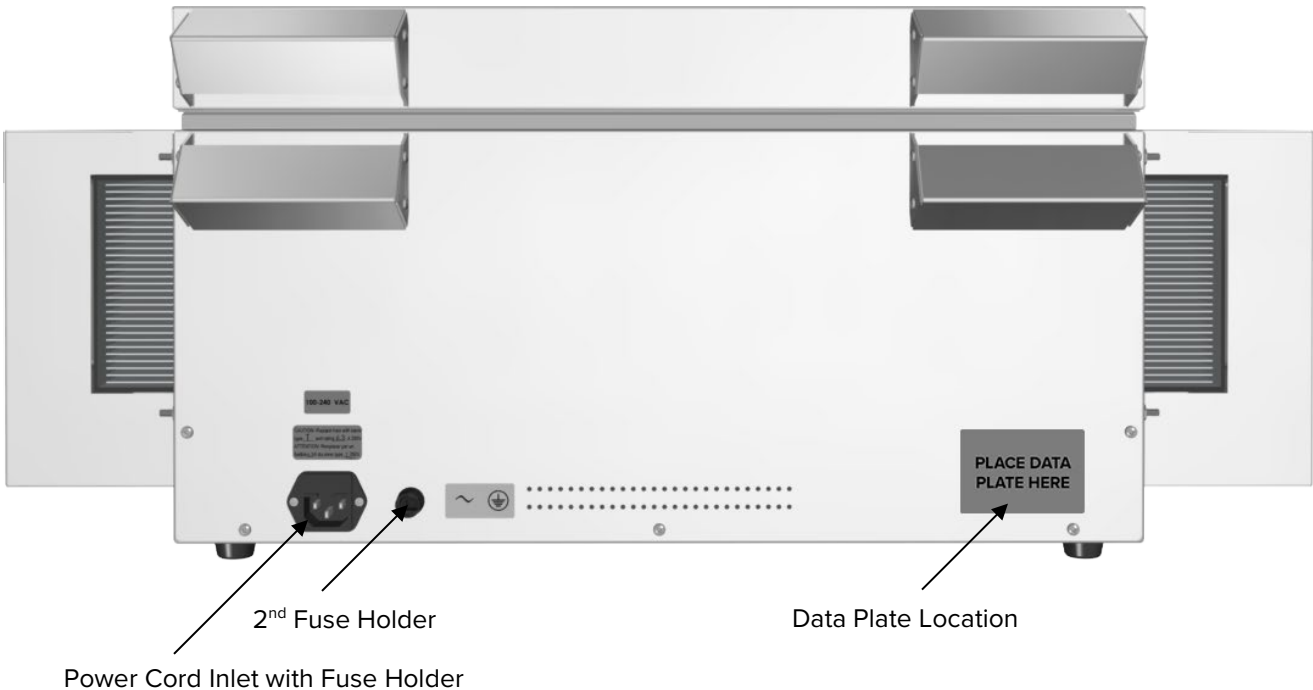

75400-707 (7 Liter Bath)

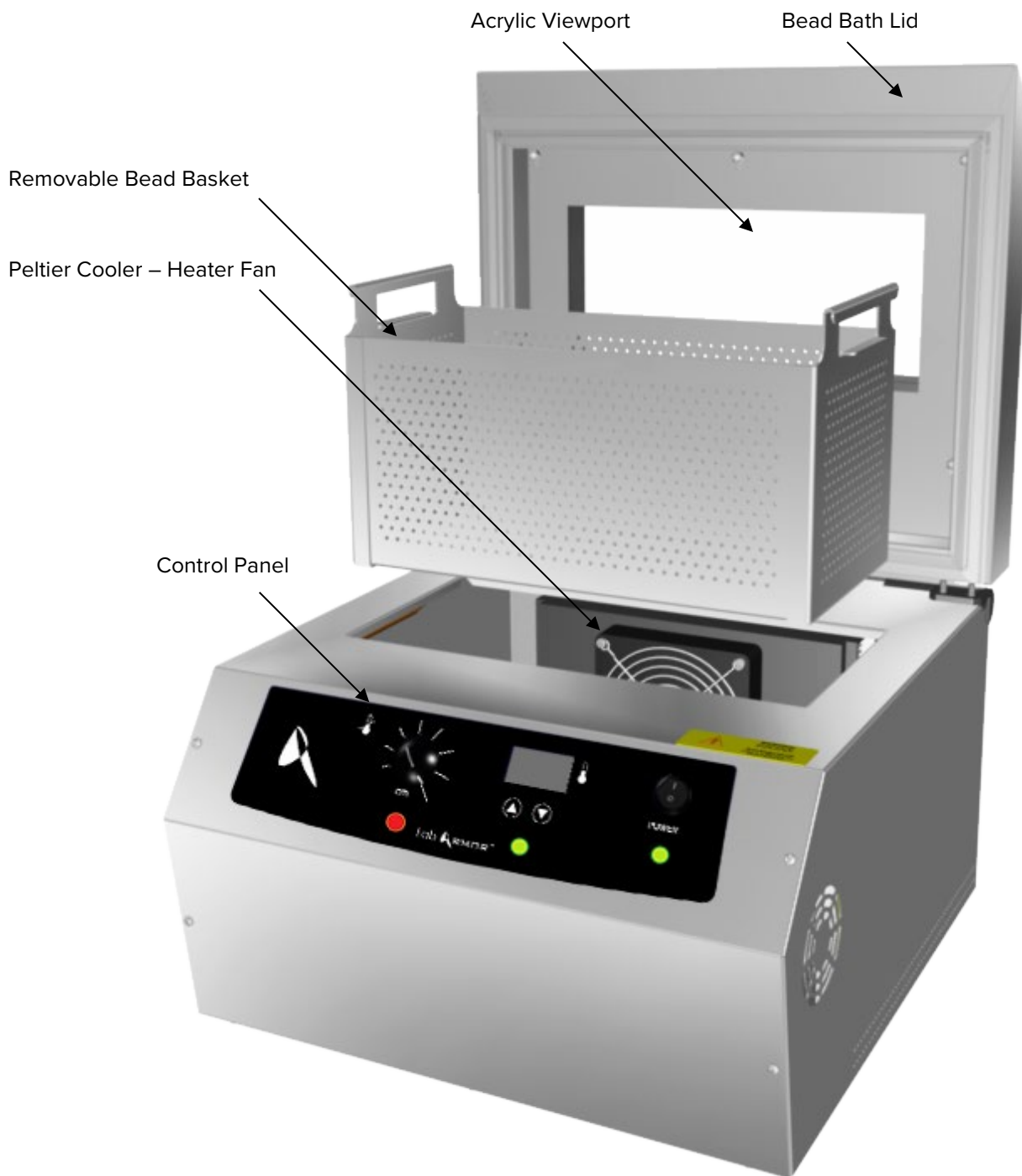

Back, 75400-707

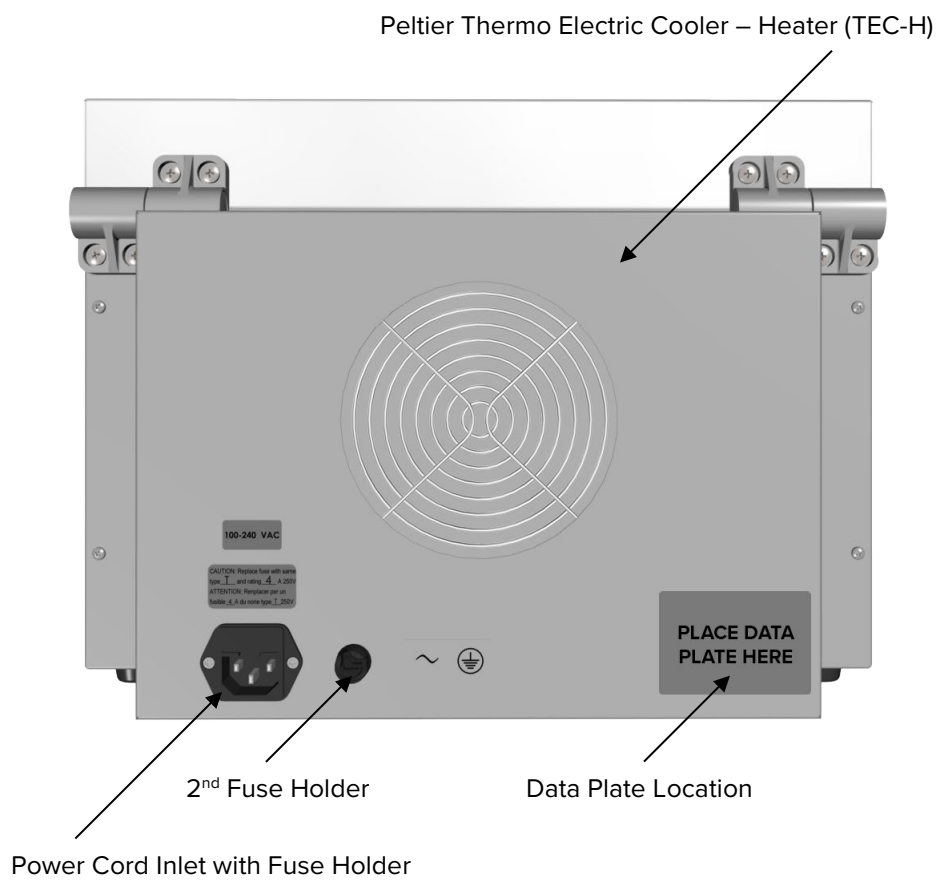

RECORD THE DATA PLATE INFORMATION

Record the unit **model number**, **serial number**, and **part number** below for future reference. Customer Support needs this information to provide accurate help during support calls and emails.

- The data plate is located on the back, left side of the unit, opposite the power cord inlet.

MODEL NO:	
SERIAL NO:	
PART NO:	

INSTALLATION PROCEDURE CHECKLIST

For installing the unit in a new workspace location.

Pre-Installation.

- ✓ Verify the required ambient conditions can be met for the unit, page 18.
- ✓ Check that the spacing clearance requirements are met, page 19.
 - Unit dimensions may be found on page 47.
- ✓ Verify a suitable electrical outlet and power supply is present, page 20.

Install the bead bath in a suitable workspace location.

- ✓ Review the lifting and handling instructions, page 21.
- ✓ Make sure the unit is level, page 21.
- ✓ Install the unit in its workspace location, page 21.

Set up the bead bath for use.

- ✓ Clean and disinfect the unit and beads (recommended), page 22.

REQUIRED AMBIENT CONDITIONS

Ambient Temperature Ranges: These units are built for use indoors under climate-controlled conditions.

75400-707

- In workspace temperatures of **15°C to 23.4°C** (59°F to 74.0°F) the 7-liter bath can achieve an operational temperature range of 2°C to 70°C.
- Sustained workspace temperatures of **23.5°C to 30°C** (74.3°F to 86°F) will gradually raise the bath's lowest achievable operating temperature. See page 48.

75400-714

- In workspace temperatures of **15°C to 25.4°C** (59°F to 77.7°F) the 14-liter bath can achieve an operational temperature range of 2°C to 70°C.
- Sustained workspace temperatures of **25.5°C to 30°C** (77.9°F to 86°F) will gradually raise the bath's lowest achievable operating temperature. See page 48.

The following ambient conditions may affect the unit temperature performance.

- **Ambient Temperature Variation:** The workspace temperature should not change by 2°C (3.6°F) or more during operation.
- **Maximum Humidity:** No greater than 80% Relative Humidity (at 25°C / 77°F).

Air Quality: The units are rated to operate in a Pollution Degree 2 environment.

Maximum Altitude: 2000 meters (6562 feet).

Additional Environmental Factors: When selecting a location to install the unit, consider all environmental conditions that can adversely impact its temperature performance. These include:

- Proximity to ovens, autoclaves, or any other device producing significant radiant heat.
- Heating and cooling vents or other sources of fast-moving air currents.
- High-traffic areas.
- Direct sunlight.

Note: Operating the unit above **60% Relative Humidity** may result in condensation forming on the acrylic viewport. This does not impact the unit performance or functionality.

REQUIRED CLEARANCES

These clearances are required to provide airflows for ventilation, cooling, and lid openings.

4 inches (102 mm) clearance is required on the sides and back.

4 inches (102 mm) minimum headspace clearance is required between the top of the unit and any overhead partitions for cooling purposes.

Ensure that there is sufficient overhead clearance for operators to fully open the lid.

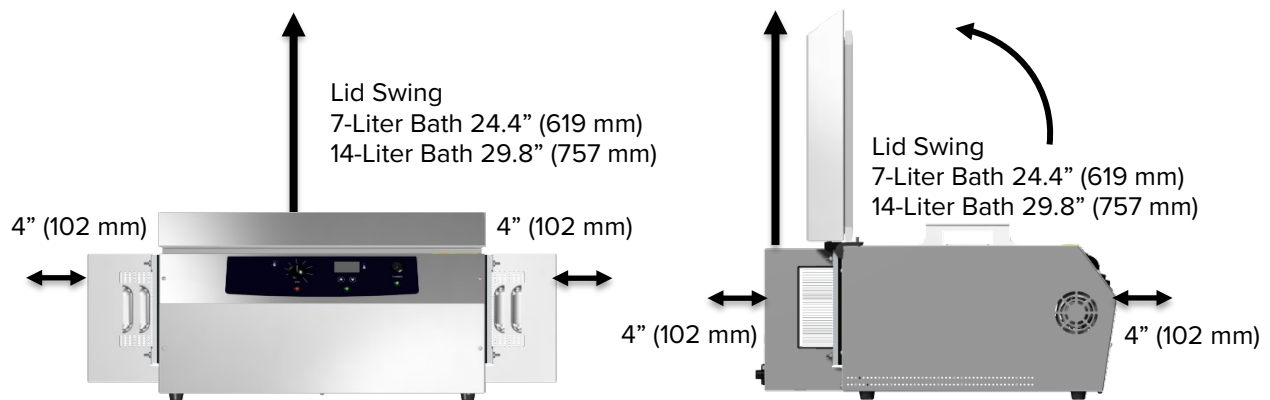

INSTALLATION

POWER SOURCE REQUIREMENTS

When selecting a location for the unit, verify each of the following requirements is satisfied:

Power Source

The power source must match the voltage and power rating requirements listed on the unit data plate.

Model	Voltage	Max Power Draw	Cycle
75400-707	100 – 240	275W	50/60 Hz
75400-714	100 – 240	550W	50/60 Hz

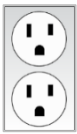

or

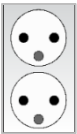

- The wall power source must be **protective earth grounded and single phase**.
- The unit may be damaged if the supplied voltage varies by more than 10% from the data plate rating.
 - The unit is safety-rated to withstand transient overvoltage levels up to Overvoltage Category II.
- Use a separate circuit to prevent loss of the unit due to overloading or circuit failure.
- The recommended wall circuit breaker for units using the 100 – 120-volt cord is **15 amps**.
- The recommended wall circuit breaker for units using the 220 – 240-volt cord is **20 amps**.
- The wall power source must conform to all national and local electrical codes.

Power Cords: The unit must be positioned so all operators can quickly unplug the power cord in the event of an emergency. Each of the units comes with the following power cord types.



- **NEMA 5-15P, 125V, 15A, 9ft 5in (2.86m)**, power cord.
- **CEE 7/7, 250V, 10 amp, 8ft 2in (2.5m)**, power cord.

Always use one of these cords or its identical replacement.

Fuses: Each unit ships with two fuses installed in the power cord inlet and a fuse holder adjacent to the inlet.



- Both fuses must be installed and intact for the unit to operate.
- Always find and fix the cause of a blown fuse prior to putting the unit back into operation.
- Fuse types:
 - **75400-707:** 250V, T4A, 5x20mm
 - **75400-714:** 250V, T6.3A, 5x20mm

INSTALLATION

LIFTING AND HANDLING

The unit is heavy. Use appropriate lifting devices that are sufficiently rated for these loads. Follow these guidelines when lifting the unit.

- Lift the unit only from its bottom surface.
- Handles and knobs are not adequate for lifting or stabilization.
- Restrain the unit completely while lifting or transporting so it cannot tip.
- Remove all moving parts, such as baskets and beads, during transfers to prevent shifting and damage.

LEVELING

The bead bath is equipped with non-adjustable rubber feet to raise it off the counter and prevent sliding. Ensure that the unit is on a flat and level surface prior to placing the unit in operation. The unit should not be used in mobile applications.



INSTALL THE BEAD BATH

Install the unit in a workspace location that meets the criteria discussed in the previous entries of the Installation section.

DEIONIZED AND DISTILLED WATER

Do not use deionized water to clean the unit, even if DI water is readily available in your laboratory.

- The use of deionized water may corrode metal surfaces and **voids the manufacturing warranty**.
- The manufacturer recommends the use of distilled water in the resistance range of 50K Ohm/cm to 1M Ohm/cm, or a conductivity range of 20.0 uS/cm to 1.0 uS/cm, for cleaning applications.

INSTALLATION CLEANING AND DISINFECTING

The manufacturer recommends cleaning and disinfecting the unit and accessories prior to installing the bead baskets in the unit.

Cleaning the Unit

- The unit was cleaned at the factory but may have been exposed to contaminants during shipping.
- Remove all wrappings and coverings from the bead baskets before cleaning and installation.
- Please see the [Cleaning and Disinfection](#) procedures on page 37 in the User Maintenance chapter for information on how to clean and disinfect without damaging the unit.
- **The unit is not watertight.** Do not fill the unit with water for cleaning.









Cleaning the Beads



- **Always wear gloves when handling the beads** to avoid contaminating the beads and the bath.
- Remove all packaging materials from the beads prior to cleaning.
- See page 38 in the User Maintenance chapter for information on cleaning and disinfecting Lab Armor beads.
- **Do not place the beads in the unit at this time.**

GRAPHIC SYMBOLS

The unit is provided with graphic symbols on its exterior. These identify hazards and adjustable components as well as important notes in the user manual.

Symbol	Definition
	Consult the user manual Consulter le manuel d'utilisation
	Temperature display Indique l'affichage de la température
	Over Temperature Limit system Thermostat température limite contrôle haute
	AC Power Repère le courant alternatif
	I/ON O/OFF I indique que l'interrupteur est en position marche. O indique que le commutateur est en position d'arrêt.
	Adjusts UP and DOWN Ajuster le haut et vers le bas
	Recycle the unit. Do not dispose of in a landfill. Recycler l'unité. Ne jetez pas dans une décharge
	Protective earth ground Terre électrique
	Caution hot surface Attention surface chaude



CONTROL OVERVIEW

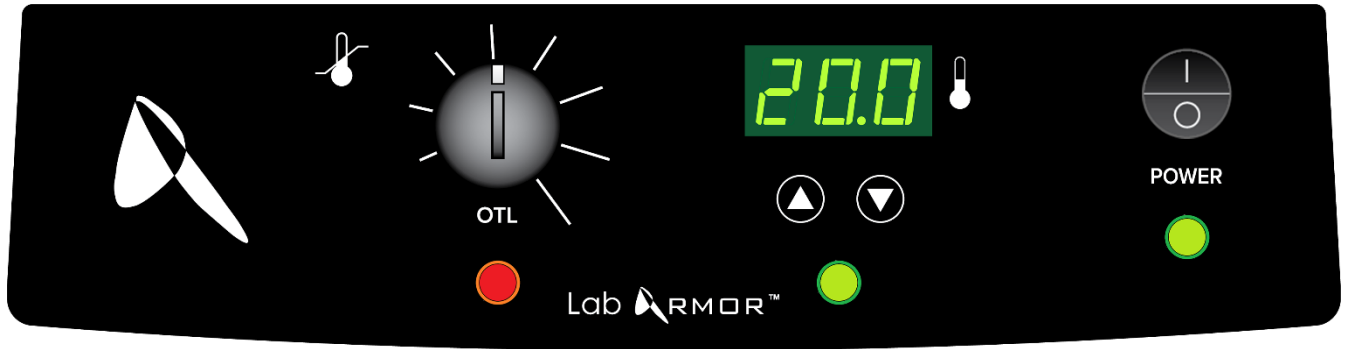

Control Panel

Over Temperature Limit Control (OTL)

This graduated dial sets the mechanical heating cutoff for the Over Temperature Limit system (OTL). The OTL helps prevent unchecked heating of the unit in the event of a hardware failure or external heat spike. For more details, please see the [Over Temperature Limit System](#) description in the Theory of Operations (page 27).

The red light illuminates when the OTL system cuts power to the Peltier heating circuits.



Power Switch

Power is supplied when the switch is in the (I) ON position.

The green Power light illuminates when the unit is turned on.



Temperature Control and Display

During normal operations, the display shows the current unit interior air temperature, accurate to 0.1°C. The Up and Down arrow buttons are used to change display modes and input temperature setpoints or calibration adjustments. The display blinks continually while in setpoint or calibration adjustment modes, preceded by an "SP" for Setpoint or "C O" for Calibration Offset.

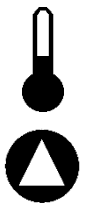

Heating and Cooling Indicator

The green light illuminates when the bath is actively chilling or heating.





THEORY OF OPERATION

Peltier Heating and Cooling

The bead bath employs a solid-state thermoelectric cooling-and-heating (TEC-H) device or devices, which operates using the Peltier effect to supply heating or cooling as needed. The 14-liter bath uses two Peltier devices, the 7-liter bath uses one.



The Peltier effect: An electrical current between two touching but dissimilar conductor plates produces a heat flow from one plate to the other. The flow direction can be flipped by reversing the current direction. The sandwiched TEC-H conductors effectively operate as a reversible high-efficiency heat pump.

A fan attached to the TEC-H blows air cooled or heated by the chamber-side Peltier plate into the bath well. This in turn heats or chills the beads in the baskets in the well to achieve the current setpoint target temperature.

When powered, the bead bath automatically heats or chills to and then maintains the operator-selected temperature setpoint. The bath controller senses the bead temperature via a solid-state probe located in the unit interior. When the bead bath controller detects a temperature deviation from the target setpoint, it pulses power to the Peltier thermoelectric cooling and heating (TEC-H) devices.

The bath controller uses Proportional – Integral – Derivative (PID) algorithms to avoid significantly overshooting the setpoint. This means the rate of heating or cooling slows as the temperature approaches the target temperature.

Additionally, the PID loops optimize heating and cooling rates for the temperature environment around the bead bath. If the bead bath is operating in a cool room, it will increase the length of heating pulses to compensate. Likewise, when operating in a warm room the bead bath uses shorter pulses to heat. If the ambient temperature conditions are significantly changed, there may be minor over or undershoots as the unit adapts.

Beads Required for Temperature

The unit will not operate properly if any chamber well space is not occupied by a properly filled bead basket. The PID algorithmic temperature controller is optimized to account for the heavy mass of the metal beads and the presents of the baskets. This means you cannot run the bath with only one 3-liter basket in a well space. Either two properly filled 3-liter baskets or one properly filled 7-liter basket must be present in each well.



The Over Temperature Limit System (OTL)

The OTL helps safeguard the unit by preventing runaway heating in the event of hardware failures or sudden external heat spikes within a range of 20° – 120°C. The system is an operator-set, mechanical heating cutoff connected to a hydrostatic sensor probe located in the unit interior. It operates independently of the unit temperature controller. If the bath temperature is higher than the OTL setting, the system routes power away from the Peltier TEC-H device or devices. In other words, the Peltier chiller – heater will not heat or chill while the OTL system is active.

The OTL must be set by the operator in order for it to function. The manufacturer recommends a setting of approximately 1°C above the highest temperature setpoint of any heating application from 20 to 70°C. A red indicator illuminates when the OTL is rerouting power.

The cutoff does not safeguard the unit against under-temperature events (too cold).

The OTL also cannot prevent a rise in heat caused by a failure of the Peltier TEC-H or its refrigeration function. If refrigeration fails while the bath is operating at a temperature below 20°C, the bath temperature will rise to slightly above the ambient temperature.

PUT THE BEAD BATH INTO OPERATION

Perform the following steps and procedures to put the unit into operation after installing it in a new workspace environment.

1. Plug in the Power Cord



Attach the power cord that came with the unit to the power inlet receptacle on the back of the unit.

Plug the power cord into the workspace electrical supply outlet.

2. Fill with Lab Armor Beads



Perform the [Fill with Lab Armor Beads](#) procedure on page 31.

3. Turn on the Bead Bath



Place the unit **Power Switch** in the ON (I) position.

4. Set the Temperature Setpoint



Perform the [Set the Temperature Setpoint](#) procedure on page 33.

- This sets the bath to run at your application temperature.



Continued next page

OPERATION

Continued from the previous page.

5. Allow the filled bath to heat or chill for a minimum of 8 hours



Wait 8 Hours

Run the unit for at least 8 hours undisturbed (for example, overnight) with the lid closed prior to:

- Calibrating the Temperature Display.
- Setting the Over Temperature Limit.
- Loading samples.

This helps ensure a stable temperature in the bath.

6. Calibrate the Temperature Display

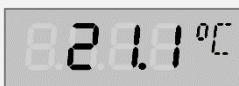

Use the [Calibrate the Temperature Display](#) procedure on page 41 when first putting the bead bath into operation and each time the setpoint is changed.

7. Set the Over Temperature Limit

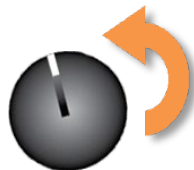

Use the [Set the Over Temperature Limit](#) procedure if you will be running the bath at 20 to 70°C. See page 34.

- The unit must be **stable** at your application temperature to perform this procedure.

The bead bath is now ready for use.

- You may [Load Samples](#), page 35.

End of Procedure

OPERATION

FILL WITH LAB ARMOR BEADS

Warning: The basket is not watertight. Do not fill the basket with liquids. Use beads only.

Avertissement: Le réservoir n'est pas étanche. Ne remplissez pas le réservoir de liquide. Utilisez des perles seulement.



Reminder: The beads should be cleaned and disinfected before filling the basket. See page 38.

- Always wear gloves to avoid contaminating the beads when handling.



74500-714s: These 14-liter bath units require bead-filled baskets in both wells for the bath to function properly. The filled baskets must occupy the entirety of the well-space. Leaving a basket well empty or partially empty will adversely impact temperature performance.

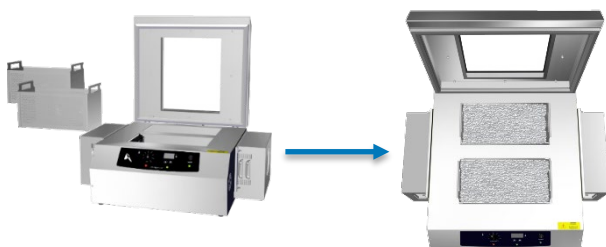

1. Fill the basket with beads.

- See page 9 for the recommended volume of beads for your unit.
- Leave approximately **1 inch (25 mm)** of space from the top of the basket.

Note: The bead level will rise when samples are loaded.

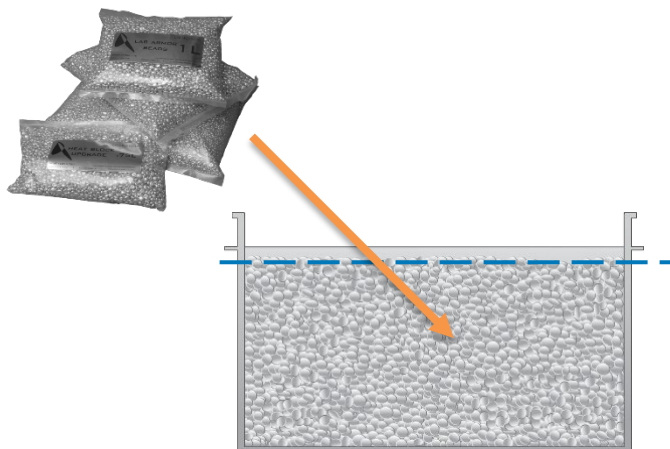

Continued next page

OPERATION

Continued from the previous page.

2. Place the basket inside the bath's basket well.

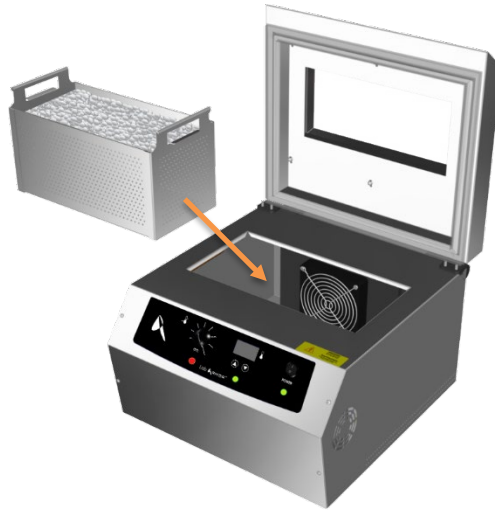

3. Close the bath lid.

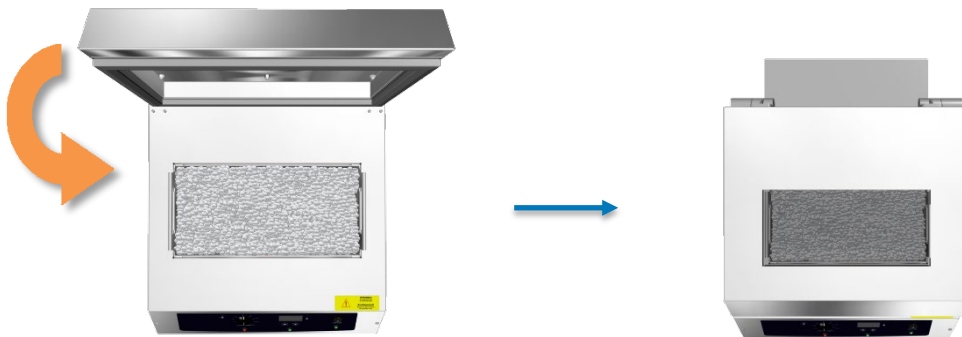

Putting into Operation – Power

- If you are putting the unit into operation after installing it in a new location, turn on the unit. Do not load samples at this time.

End of Procedure

OPERATION

Note: The temperature controller should be calibrated when putting the bath into use and each time the temperature setpoint is changed. See page 41.

SET THE TEMPERATURE SETPOINT

Perform the steps below to adjust the setpoint to your process or application temperature.



1. Set the OTL control to its maximum setting, if not already set to max

- This prevents the heating cutoff system from interfering with this procedure.

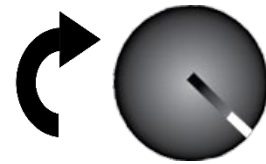

2. Put the bath in Temperature Setpoint adjustment mode.



Briefly push and release either the **Up** or **Down** arrow buttons to activate the temperature setpoint adjustment mode.

- The display will briefly flash the letters “SP”, then show the flashing, adjustable temperature setpoint.

Note: The display will automatically exit the adjustment mode after 5 seconds of inactivity, with the last shown setpoint value saved.



Setpoint Adjustment Mode



Initial Setpoint

3. Set the Temperature Setpoint.



Use the **Up** and **Down** arrow buttons to change the temperature setpoint.



New Setpoint

4. Wait 5 seconds after entering the Setpoint.



Wait 5 Seconds

- The display will stop flashing, and the setpoint is now saved in the controller.
- The unit will now automatically heat or chill to match your setpoint.
- The display will revert to showing the current unit interior air temperature.



Chilling to the Setpoint



End of Procedure

OPERATION

Note: Test the OTL system at least once per year to verify its functionality. **Failure to set the OTL voids the manufacturing defect warranty if over temperature damage occurs.**

SET THE OVER TEMPERATURE LIMIT (OTL)



Set the OTL if you will be running the bath at 20 to 70°C. This procedure sets the mechanical heating cutoff to approximately 1°C above the current bath temperature. **Perform this procedure when the unit has been running with no temperature fluctuations at your application temperature for at least 8 hours.** Reminder: The OTL does not guard against under-chilling events.

1. Set the OTL control to its maximum setting, if not already set to max.

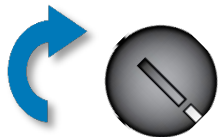

2. Turn the dial counterclockwise (to the left) until the OTL light illuminates



3. Slowly turn the dial clockwise (to the right) until the OTL light turns off

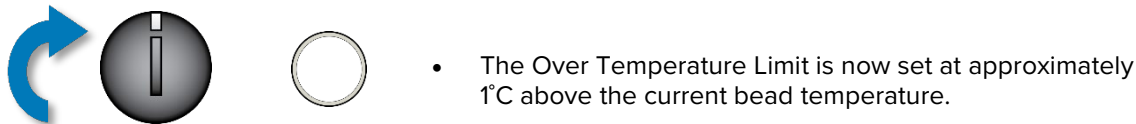

4. Leave the OTL dial set just above the activation point



Optional: Turn the dial slightly to the left (counterclockwise)

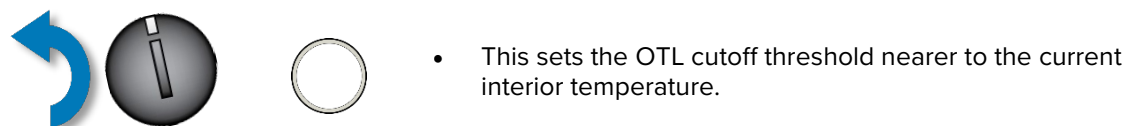

If the OTL sporadically activates after setting the control, turn the dial very slightly to the right (clockwise).

If the OTL continues activating, check for ambient sources of heat or cold that may be adversely impacting the unit temperature stability. If you find no sources of external or internal temperature fluctuations, contact Customer Support or your distributor for assistance.

End of Procedure

OPERATION

Warning: The bead basket handles may be hot to the touch if the unit has been operating above 50°C. Proper PPE should be employed to minimize the risk of burns if baskets are removed before the unit has cooled.

Avertissement: Les poignées du panier à perles peuvent être chaudes au toucher si l'appareil a fonctionné à plus de 50°C. Un EPI approprié doit être utilisé pour minimiser le risque de brûlures si les paniers sont retirés avant que l'unité n'ait refroidi.



LOADING SAMPLES

Load samples after the bath has run for at least **8 hours** and then been calibrated. This allows the temperature of the beads in the baskets to fully stabilize.

1. Load samples into the basket.

- Ensure that the combined volume of samples and beads does not cause the basket to overflow.
- Samples must be surrounded by beads without touching the sides and bottom of the basket to avoid uneven heating.

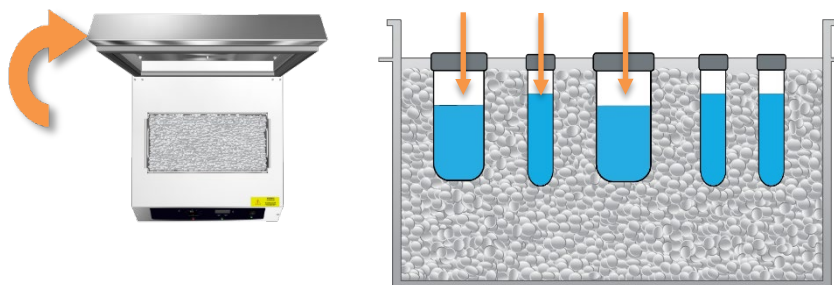

2. Close the bead bath lid.



End of procedure

PROCESS TRANSITION FROM WATER BATHS

If your laboratory previously used water baths for your application, keep the following in mind. Heat transfer in a bead bath functions differently from water baths and water bath application protocols must be reevaluated and validated when switching from a bead bath. Applications involving large or frozen vessels may take 2 – 3 times longer to achieve the target setpoint than in a water bath due to the high thermal stability of the beads. Bringing the temperature of frozen samples up to 4°C before placing them in the bead bath can help optimize heat-up times.

Warning: Disconnect the unit from its power supply prior to performing maintenance or services.

Avertissement: Débranchez cet appareil de son alimentation électrique avant d'effectuer la maintenance ou les services.



CLEANING AND DISINFECTING THE BATH

If a hazardous material or substance has spilled in the basket, immediately initiate your site Hazardous Material Spill Containment protocol. Contact your local Site Safety Officer and follow instructions per the site policy and procedures.

- Periodic cleaning and disinfection are required.
- Do not use spray-on cleaners or disinfectants on the exterior of the unit. These can leak through openings and coat electrical components.
- Consult with the manufacturer or their agent if you have any doubts about the compatibility of decontamination or cleaning agents with the parts of the equipment or with the material contained in it.
- Do not use cleaners or disinfectants that contain solvents capable of harming paint coatings or stainless-steel surfaces. **Do not use chlorine-based bleaches or abrasives; these will damage the basket and unit interior.**

Warning: Exercise caution if cleaning the unit with alcohol or flammable cleaners. Always allow the unit to cool down to room temperature prior to cleaning and make sure all cleaning agents have evaporated or otherwise been completely removed prior to putting the unit back into service.

Avertissement: Soyez prudent lorsque vous nettoyez l'appareil avec de l'alcool ou des produits de nettoyage inflammables. Laissez toujours refroidir l'appareil à la température ambiante avant le nettoyage et assurez-vous que tous les produits de nettoyage se sont évaporés ou ont été complètement enlevés avant de remettre l'appareil en service.



Suggestions for Cleaning the Bath

Keep the following in mind when cleaning the unit:

- Always disconnect the unit from its power supply.
- Remove all removable accessory components such as the beads and the basket(s) if permitted by your laboratory protocol.
- Clean the unit with a mild soap and water solution, including all corners.
 - **Do not use an abrasive cleaner.** These will damage metal surfaces.
 - **Do not use deionized water to rinse or clean with.**
 - Take special care when cleaning around the temperature sensor probes in the chamber to prevent damage. Do not clean the probes.
- Clean with a lint-free towel dampened with distilled water and wipe dry with a soft cloth.

Disinfection Considerations

- Always follow your laboratory or study protocols when disinfecting the bath.
- Always turn off and disconnect the unit to safeguard against electrical hazards.
- For maximum effectiveness, disinfection procedures are typically performed after cleaning.
- The beads and baskets must be removed from the well(s) to successfully disinfect the bath.
 - The beads and basket(s) must be disinfected separately.
 - **Do not autoclave the bead baskets.** This will discolor them.
- Disinfect the unit using commercially available disinfectants that are non-corrosive, non-abrasive, and suitable for use on stainless steel, aluminum, plastic, and acrylic surfaces. Contact your local Site Safety Officer for detailed information on which disinfectants are compatible with your applications.
- Disinfect all surfaces in the well, making sure to thoroughly disinfect the corners. Exercise care to avoid damaging the sensor probes.
- Gas concentrations from evaporating disinfecting agents can inhibit growth or cause metabolic symptoms in microbiological sample populations. Make sure that chlorines, quaternary ammonias, or any other overtly volatile disinfecting agents have been rinsed or otherwise removed from the unit surfaces, prior to placing samples in the basket(s).

When disinfecting external surfaces, use disinfectants that will not damage painted metal, aluminum, glass, and plastic.

CLEANING AND DISINFECTING LAB ARMOR BEADS



Clean and disinfect the beads as often as required by your laboratory protocol. **Always wear gloves when handling the beads to avoid contaminating the beads and bath.**

Cleaning the Beads

1. Remove the beads from the basket(s).
2. Clean with a mild soap and water solution.
 - **Do not use abrasive cleaners.** These will damage the surface of the beads.
 - **Do not autoclave the beads.** This will cause pitting on the polished aluminum surfaces.
 - **Do not use deionized water to rinse or clean with.**
3. Rinse with distilled water and disinfect before use.

Considerations for Disinfecting the Beads

- The beads must be removed from the basket(s) to ensure disinfection.
- The beads may be disinfected with a solution of isopropanol (IPA). Always ensure that all bead surfaces have been sufficiently coated.
- The manufacturer recommends allowing the IPA solution to air dry. This helps ensure that the beads have had sufficient contact time to be thoroughly disinfected.
- Ensure that disinfecting agents have fully evaporated, and the beads are completely dry before returning the beads to the basket.

Decontaminating the Beads

Beads may be decontaminated by baking with dry heat at 170°C for 2 hours.

- The beads must be removed from the bead baskets and spread out in a single layer on a flat surface to ensure decontamination.
- **Do not bake the bead baskets** with or without beads in them.

MINIMIZING CONTAMINATION EXPOSURE

The following are suggestions for minimizing exposure of the unit to potential contaminants.

- Maintain a high air quality in the laboratory workspaces around the unit.
- Avoid placing the unit near sources of air movement such as doors, air vents, or high traffic routes in the workspace.

ELECTRICAL COMPONENTS

Electrical components do not require maintenance. If the unit fails to operate as specified, please contact your distributor or [Customer Support](#) for assistance.

SAFETY AFTER REPAIRS AND MAINTENANCE

Verify the unit is in a safe state before returning it to operation after repairs or maintenance procedures are performed on it.

MOVING OR STORING THE BEAD BATH

If the bath has been operating below the ambient temperature for the past 7 days, perform the following steps before moving the unit or preparing it for storage. These steps dry the bath internal spaces and avoid spills in the unit interior. These spills can leak out of the unit.

Fluid source: Operating in the bath in its chilling mode for extended periods may cause condensation buildup on the internal Peltier fins. This condensate must be evaporated before transport.

1. Remove beads and the basket from the well.
2. Using a small object, prop the lid open so that it is slightly ajar, approximately 1". This will allow for atmospheric exchange without losing too much heat.
3. Set the temperature setpoint to 50°C to heat the unit interior. This will help speed condensation drying.
 - **Note:** The unit may not achieve the setpoint during this procedure.
4. Allow the bath to run undisturbed for 24 hours, or until all the condensate has evaporated.
5. Depower the bead bath.
6. Clean and disinfect if required by your laboratory protocol or if the unit has been exposed to pathogenic microorganisms.
7. Use a soft cloth to dry the unit surfaces.

CALIBRATE THE TEMPERATURE DISPLAY

Note: Performing a temperature display calibration requires a temperature reference device. Please see the [Reference Sensor Devices entry](#) on page 10 for device requirements.

Calibrate after setting a new temperature setpoint and as often as required by your laboratory or production protocol, or regulatory compliance schedule. Always calibrate to the standards and use the calibration setup required by your industry standards or laboratory protocol. Temperature calibrations are performed to match the unit temperature display to the actual temperature inside the bead-filled unit interior. The actual temperature is supplied by a calibrated reference device. Calibrations compensate for long-term drifts in the microprocessor controller as well as those caused by the natural material evolution of the sensor probe in the unit interior.



Recommended Tools



Use non-marking, heat-resistant polyamide tape to hold the reference device thermocouple probe in place. The manufacturer recommends Kapton brand tape, 0.5 inches width (12.7 mm), 2 mil thickness.

A rigid, non-conductive item, such as a wooden tongue depressor or a plastic sample rack, may be used as a horizontal brace to help hold the probe in position.

A rigid, non-conductive item, such as a wooden tongue depressor, fiberglass or plastic rod may be used as a vertical brace to help push the reference thermocouple probe into the bead mass when positioning it.

Thermocouple probe in position with braces

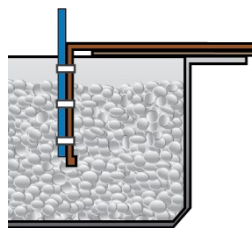

Suggested Calibration Setup

1. Configure the bath as it will be used during your process.

- The bath should have the number of baskets you will be using filled with beads and placed in the wells.
- For example, if you will be using two 3-liter baskets in a well during your application, calibrate with both baskets in and filled with beads.

Continued on next page

2. Place the sensor probe head into the center of a basket.

- Open the lid to place the probe.
- The probe may be placed in either the front or rear well of the 75400-714 bath.
- The probe head should be as close to the geometric center point of the calibrating basket as possible.
- If the unit is configured with 3-Liter baskets, either basket may be used.
- The probe head must be positioned at least **2 inches (51 mm)** above the floor of the basket to prevent heatsinking.
- **Reminder:** A rigid, non-conductive item may be used as a vertical brace to help push the probe into the bead mass.

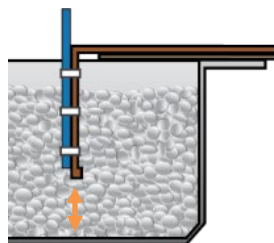

75400-714 Two 7-Liter baskets

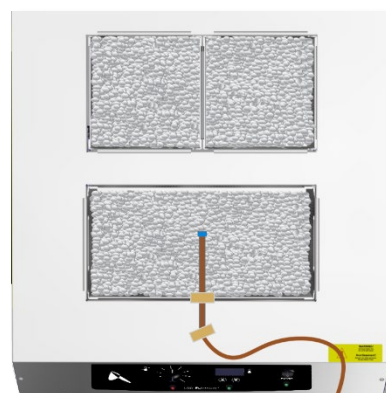

75400-714 One 7-Liter basket and two 3-Liter baskets

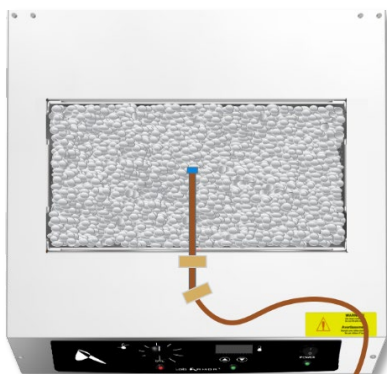

75400-707 One 7-Liter basket



75400-707 Two 3-Liter baskets

Continued on next page

3. Secure the probe wire in position.

- Use the non-marking, heat-resistant tape.
- Ensure that the probe wire slack does not come into contact with the surface of the beads.
- **Reminder:** A rigid, non-conductive item, such as a wooden tongue depressor or a sample rack, may be used as a horizontal brace to help hold the probe in position.

Probe positioned with braces

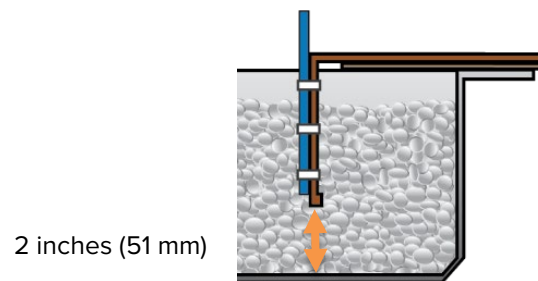

4. Carefully close the lid over the probe wire.



Continued on next page

MAINTENANCE

5. Allow the bead temperature to stabilize before calibrating.

- The bath cannot be accurately calibrated before stability is achieved.
- When first putting the bath into operation in a new location, it must run heating **or** chilling for at least 8-hours to stabilize.
- The temperature is considered stabilized when the filled bead bath has operated at your calibration temperature for at least 1 hour with no fluctuations greater than the specified temperature stability of the unit (see page 48).

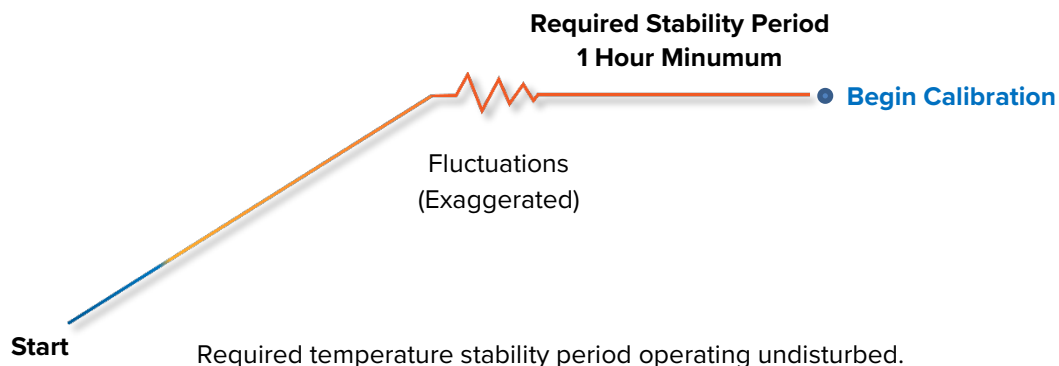

Suggested Temperature Calibration

1

Once the bead temperature has stabilized, compare the reference device and unit temperature display readings.

- If the readings are the same, or the difference between the two falls within the acceptable range of your protocol, the display is accurately showing the bead temperature. **The Temperature Calibration procedure is now complete.**

-OR-

- If the difference falls outside of your protocol range, advance to Step 2.

Reference Device



Set Temperature



2

A display calibration adjustment must be entered to match the display to the reference device. See next step.

Reference Device

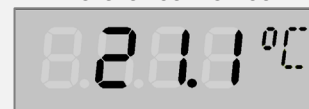

Continued next page

Temperature Calibration Continued

3

Place the display in temperature calibration mode.



- Press and hold both the **Up** and **Down** arrow buttons simultaneously for approximately 5 seconds.
- Release the buttons when the temperature display shows the letters "C O". The display will begin flashing the **current temperature display value**.



Note: The display will automatically exit calibration mode after 5 seconds of inactivity, with the last shown temperature display value saved.

4



Push the **Up** and **Down** arrow buttons to adjust the current display temperature value until it matches the reference device temperature reading.

Reference Device

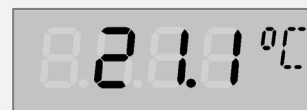

5

After matching the display to the reference device, wait 5 seconds.



Wait 5 Seconds

- The temperature display will cease flashing and store the corrected display value.
- The bead bath will now begin heating or cooling to reach the setpoint with the corrected display value.



Cooling to Setpoint

6



Wait 1 Hour

Allow the bead bath to operate for at least 1 hour undisturbed to stabilize **after the unit has achieved the corrected temperature setpoint**.

- Failure to wait until the unit is fully stabilized will result in an inaccurate reading.



Setpoint Achieved

Continued next page

Temperature Calibration Continued

7

Compare the reference device reading with the unit temperature display again.

- If the reference device and the unit temperature display readings are the same, or the difference falls within the range of your protocol, **the unit is now calibrated for temperature.**

-OR-

- See the next step if the readings fail to match or fall outside of your protocol range.

Reference Device



8

If the two readings are not the same, and the difference still falls outside the acceptable range of your protocol, repeat steps 3 – 7 up to two more times.

- Three calibration attempts may be required to successfully calibrate units that are more than $\pm 2^{\circ}\text{C}$ out of calibration.

Reference Device



9

If the temperature readings of the unit temperature display and the reference device still fall outside your protocol after three calibration attempts, contact your distributor or [Customer Support](#) for assistance.

End of Procedure

UNIT SPECIFICATIONS

These bead baths are 100 – 240-volt units. Please refer to the unit data plate for individual electrical specifications.

Technical data specified applies to units with standard equipment at an ambient temperature of 25°C and at nominal voltage. The temperatures specified are determined in accordance with factory standard following DIN 12880 respecting the recommended wall clearances of 10% of the height, width, and depth of the inner chamber. All indications are average values, typical for units produced in the series. We reserve the right to alter technical specifications at all times.

WEIGHTS

Model	Shipping	Dry Weight*	Net Weight**
75400-707	96 lb / 44 kg	46.6 lb / 21.2 kg	69.0 lb / 31.3 kg
75400-714	167 lb / 76 kg	80.8 lb / 36.7 kg	125.6 lb / 57.0 kg

*The empty bath with no beads loaded.

**The bath with the 7-Liter basket or baskets filled to the recommended volume.

DIMENSIONS

In inches

Model	Exterior W × D × H	Interior W × D × H
75400-707	16.1 x 22.1 x 12.1 in	12.5 x 6.1 x 6.0 in
75400-714	30.4 x 24.2 x 12.2 in	12.5 x 6.1 x 6.0 in*

Interior dimensions reflect usable space inside the bead basket.

*the 75400-714 has 2 baskets. These dimensions for each bead basket.

In millimeters

Model	Exterior W × D × H	Interior W × D × H
75400-707	408 x 562 x 308 mm	318 x 154 x 152 mm
75400-714	772 x 615 x 310 mm	318 x 154 x 152 mm*

Interior dimensions reflect usable space inside the bead basket.

*the 75400-714 has 2 bead baskets. These dimensions are for each basket.

SPECIFICATIONS

CAPACITY

Model	Cubic Feet*	Liters*
75400-707	0.26	7.4
75400-714	0.52	14.8

*See page 9 for the recommended volume of beads.

TEMPERATURE

Range and Stability

Model	Range	Stability @ All Temps
All	2°C* – 70°C	±0.1°C

*Workspace temperatures can affect the baths' lowest achievable operating temperature.

- **75400-707:** Sustained ambient temperatures of 23.5°C (74°F) and hotter will impact the low-end temperature performance of the 7-liter bath. The lowest sustainable bath chilling temperature rises as the workspace temperature rises.
- **75400-714:** Sustained ambient temperatures of 25.5°C (78°F) and hotter will impact the low-end temperature performance of the 14-liter bath. The lowest sustainable bath chilling temperature rises as the workspace temperature rises.

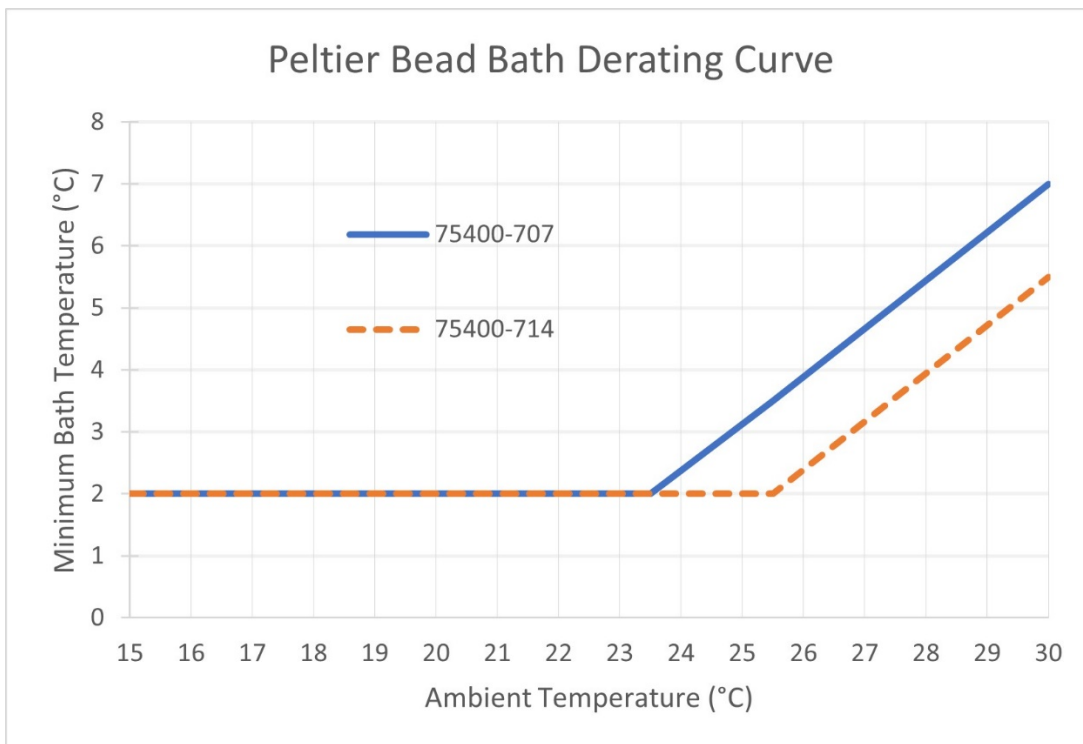

SPECIFICATIONS

Uniformity

For ambient conditions of 15C to 23.5°C

Model	Uniformity @ 4°C	Uniformity @ 37°C	Uniformity @ 70°C
75400-707	±0.4°C	±0.5°C	±1.5°C
75400-714	±0.5°C	±0.5°C	±1.3°C





POWER

Model	Voltage	Power Rating	Frequency
75400-707	100 – 240	275W	50/60 Hz
75400-714	100 – 240	550W	50/60 Hz



PARTS AND ACCESSORIES

PARTS

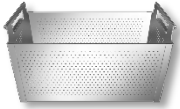

Description	Parts Number	Description	Parts Number
Fuse, 75400-707 4 amp 250V, 5x20mm (Requires 2)	 3300537	Power Cord, 110V, 15A, 9 ft 5 in (2.86 m) NEMA 5-15P	 1800510
Fuse, 75400-714 6.3 amp 250V, 5x20mm (Requires 2)	 3300515	Power Cord 230V, 10A, EUR16P, CEE 7/7, 2.5 meters (8ft 2in)	 1800500
7-Liter Aluminum Bead Basket (75400- 714 requires 2)	 9551101		

Ordering

Parts and accessories may be ordered from Sheldon Manufacturing by emailing parts@sheldonmfg.com, or by phone at 1-800-322-4897 ext. 3, or (503) 640-3000 ext. 3. Please have the **model**, **serial**, and **part** numbers of the unit ready, as Customer Support will need this information to match your unit to its correct part.

PARTS AND ACCESSORIES

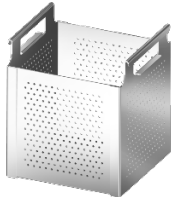
ACCESSORIES

Description	Parts Number	Description	Parts Number
Lab Armor Beads 0.75 liters 2 liters 4 liters 8 liters	 42370-750 42370-002 42370-004 42370-008	3-Liter Aluminum Bead Basket  9551102	
7-Liter Copper Bead Basket  9551103		3-Liter Copper Bead Basket  9551104	

Copper Basket Color Changes

Copper is known to have anti-microbial properties and is commonly used in hospital and laboratory applications for this purpose.

The copper baskets will gradually and permanently change color from copper to a darker tarnish and eventually a green patina over time. This is a normal process of oxidation and will not reduce the efficacy of the copper against microbes or affect the bead bath temperature performance.

Discoloration may occur more rapidly with frequent exposure to disinfecting agents.



Lab  ARMOR[®]



Lab Armor LLC
4001 East Plano Parkway Ste 200
Plano TX 75074
USA

support@labarmor.com
labarmor.com

1-469-496-2350
FAX: 1-833-257-1475